

CORRAPOL[®]-BT

Durable Bitumen **Corrugated Sheet** Installation Guide

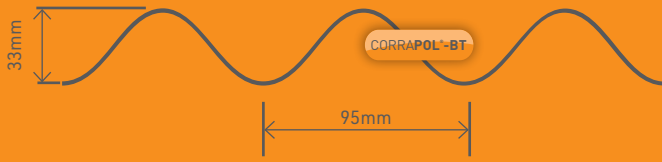

CORRAPOL®-BT : Installation Guide



CORRAPOL®-BT Corrugated Bitumen Sheet

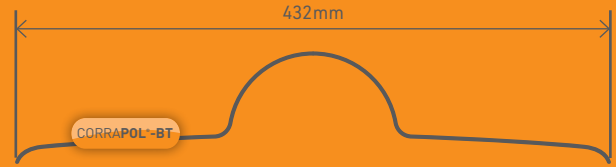

CORRAPOL®-BT Corrugated Bitumen Roof Budget Ridge

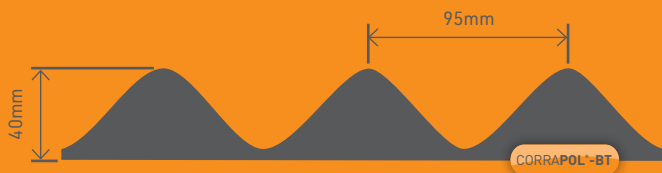

CORRAPOL®-BT Foam Eaves filler



Plastic Headed Nails



Screw Cap Fixings

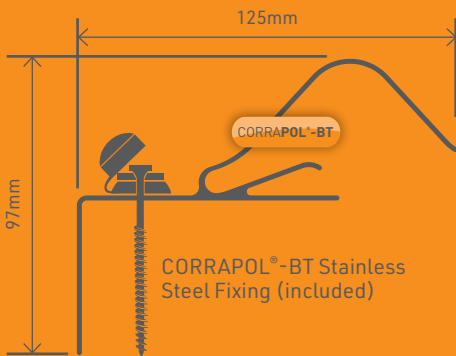

CORRAPOL®-BT Rock n' Lock Gable Flashing

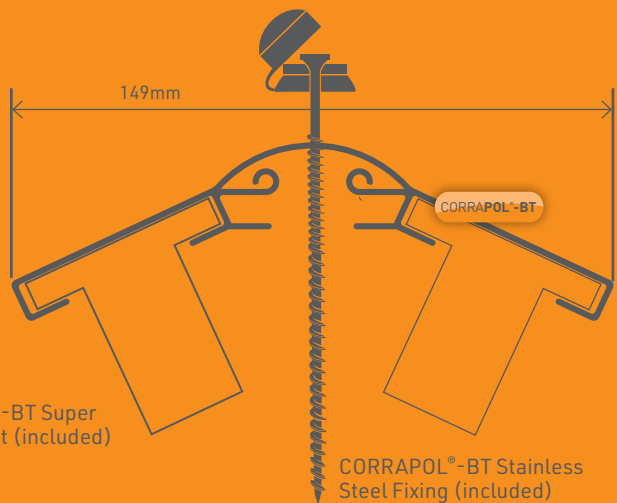

CORRAPOL®-BT Super Ridge

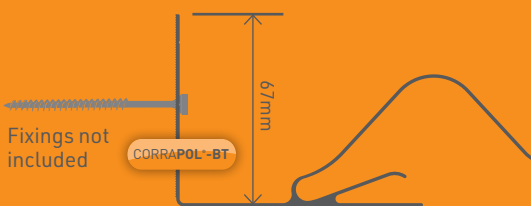

CORRAPOL®-BT Rock n' Lock Wall Flashing

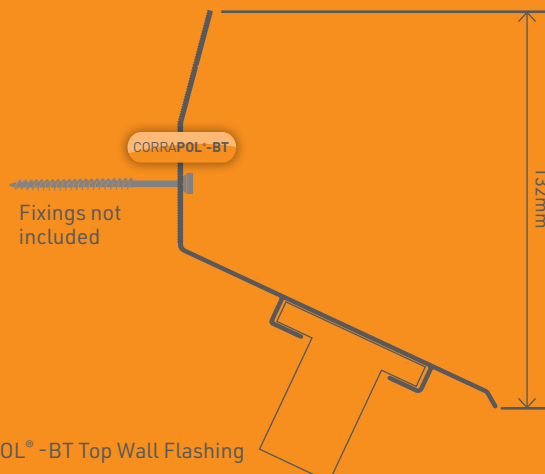

CORRAPOL®-BT Top Wall Flashing

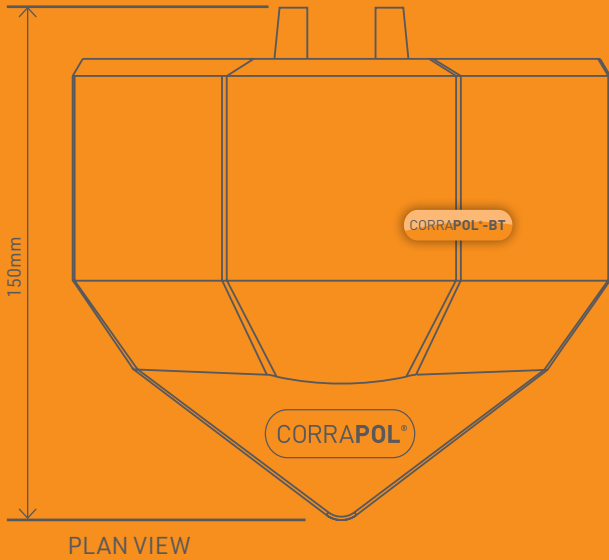

BACK VIEW

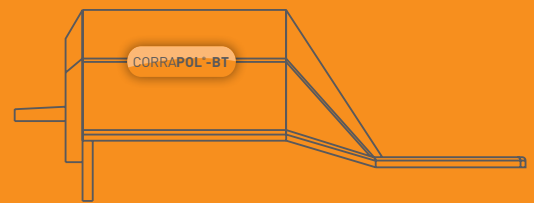

SIDE ELEVATION

CORRAPOL®-BT Super Ridge End Cap

Tools required



Wear protective gloves, glasses and ear protectors where appropriate.



Clamp, lubricating oil, universal tooth blade and tin snips.



Fine toothed bladed Chop Saw



A hammer, cordless screwdriver/drill, tape measure a straight edge tool and suitable sealant / sealant gun.

Installation

1 MEASURE the roof

IMPORTANT - Take all **MEASUREMENTS** of the roof so you can work out the correct plan for the sheet coverage. Allow an **extra 70mm overhang** on the slope length for the sheet overhang.

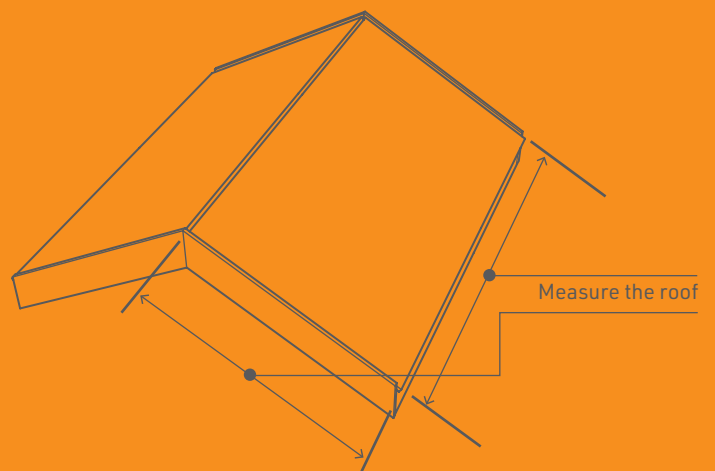

2 DETERMINE OVERLAPS for larger slopes

See diagrams below for overlap, depth and angle details

Fix intermediate roof supports every **two corrugation peaks**

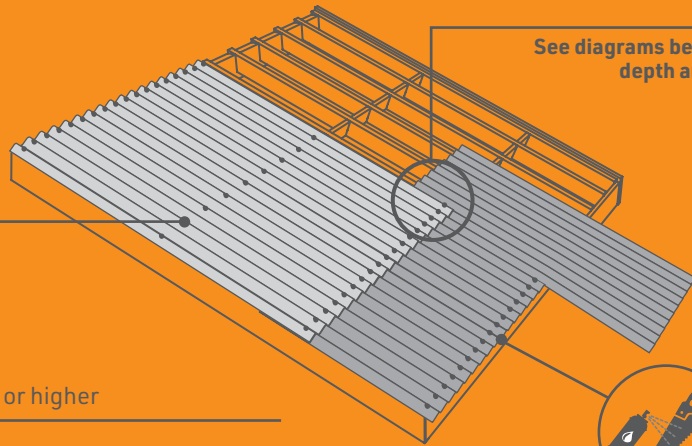

Roof slopes of 15° or greater: Gradients of 1 in 4 or higher

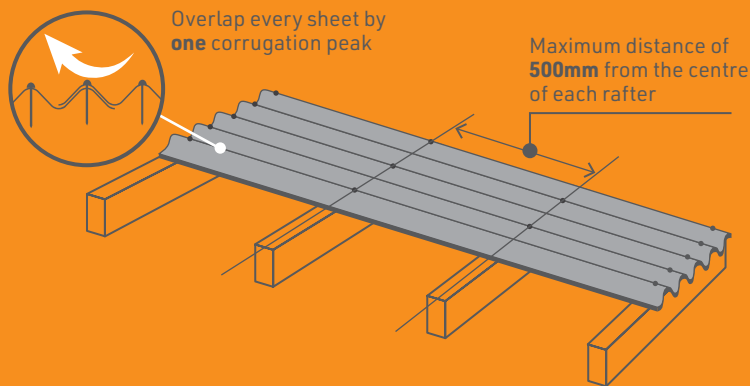

Overlapping sheets

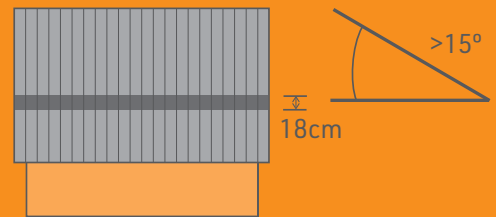

Roof slopes of 10° - 15°: Gradients of 1 in 6 - 1 in 4

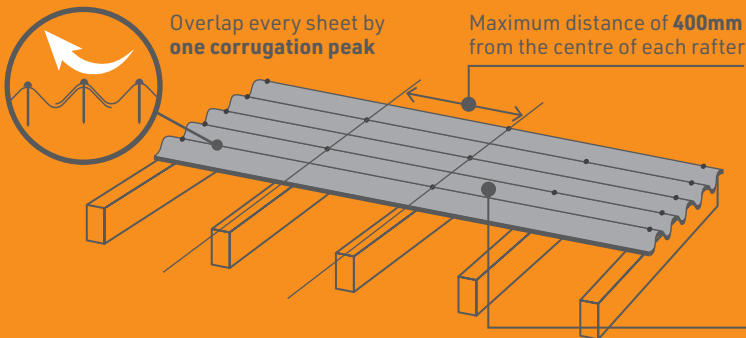

Overlapping sheets

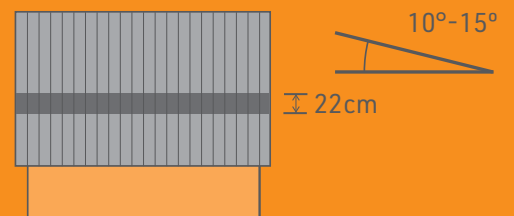

Use fixings sheets every corrugation at the eaves and sheet overlaps. Use fixings every other corrugation on intermediate purlins.

Roof slopes of 5° - 10°: Gradients of 1 in 11 - 1 in 6

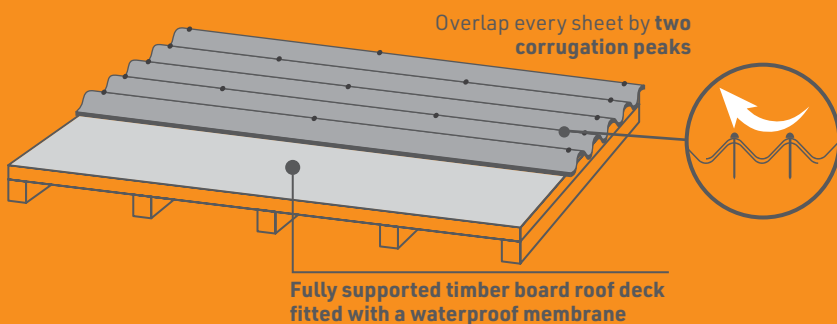

Overlapping sheets

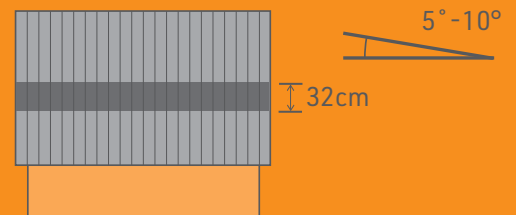

[View Our How 2 Overlap Corrugated Roof Sheets Video](#)

3 Prepare the **CORRAPOL®-BT Rock n' Lock Gable Flashing**

Cut the **CORRAPOL®-BT Rock n' Lock Gable Flashing** to the required length with a chop saw which has a fine-toothed blade suitable for cutting aluminium.

Cut a **mitre** at the top end of the **CORRAPOL®-BT Rock n' Lock Gable Flashing** so it finishes with a vertical end when offered up to the upper end of the roof slope.

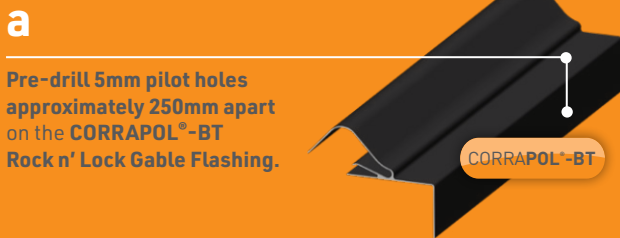
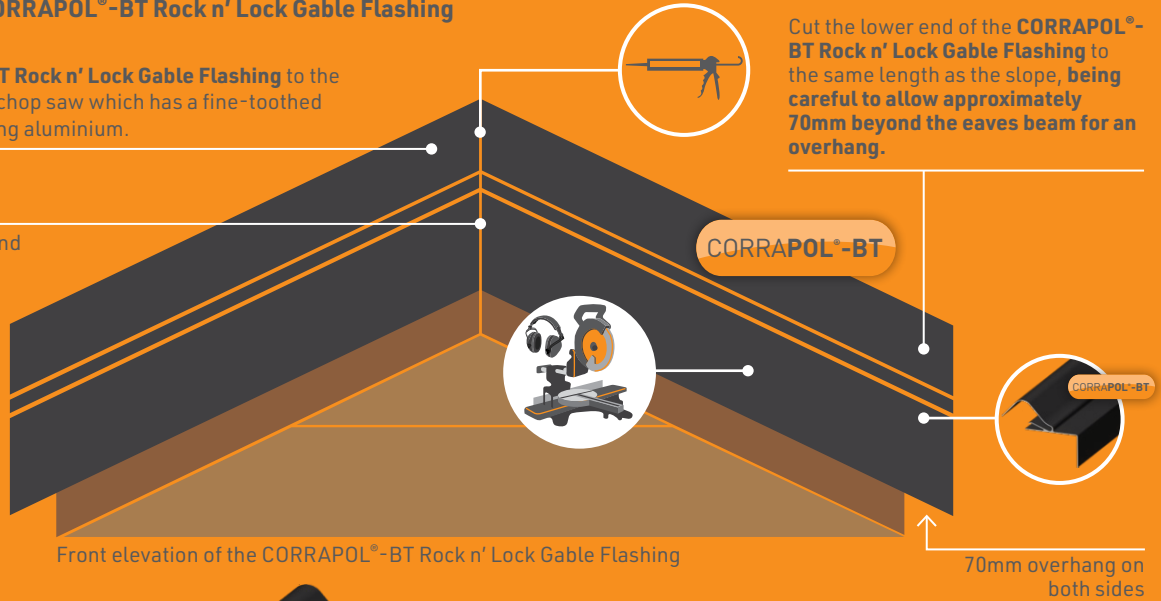

4 Prepare the **CORRAPOL®-BT Rock n' Lock Wall Flashing**

Cut a **mitre edge** at the top end of the **CORRAPOL®-BT Rock n' Lock Wall Flashing** to the same lengths as the front **CORRAPOL®-BT Rock n' Lock Gable Flashing**.

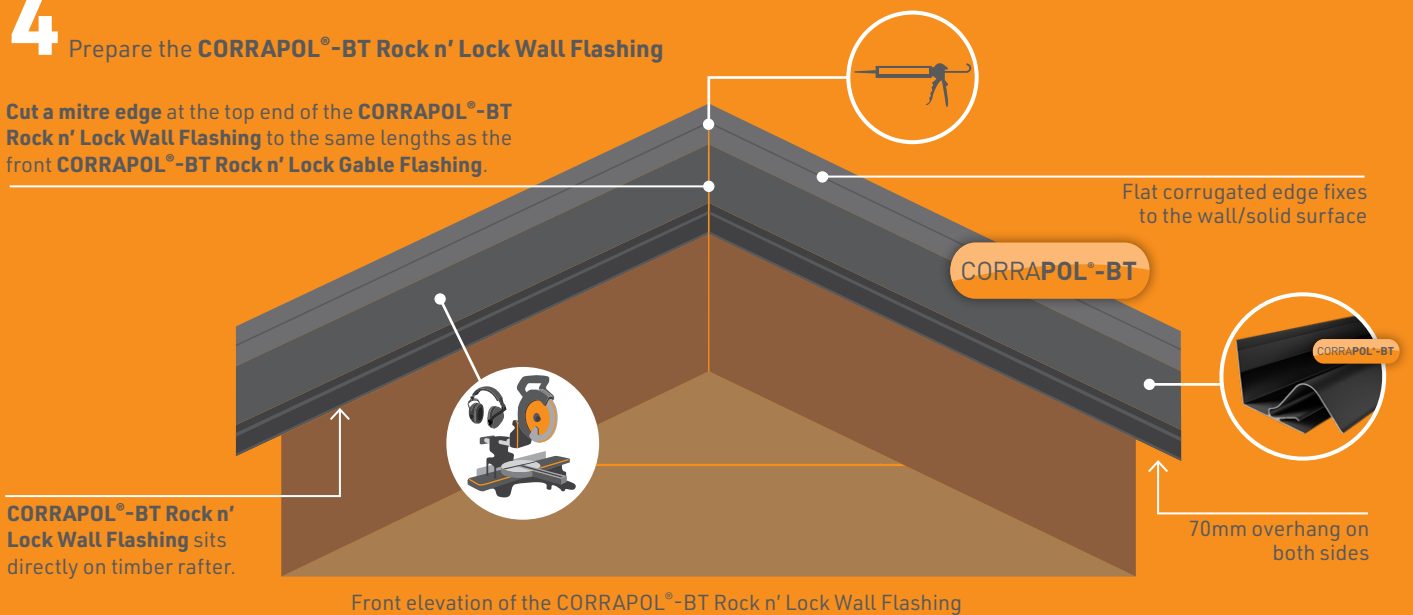

CORRAPOL®-BT

a

Pre-drill suitable sized pilot holes approximately 250mm apart for fixing the vertical back edge of the **CORRAPOL®-BT Rock n' Lock Wall Flashing** to the wall or solid surface. (Fixing to be supplied by installer)

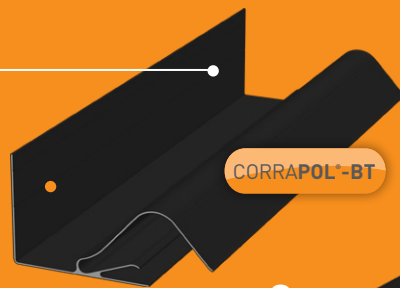

Fix the **CORRAPOL®-BT Rock n' Lock Wall Flashing** onto the wall using suitable stainless steel screws approximately 250mm distance between each fixing.

b

Tilt the **CORRAPOL®-BT Rock n' Lock Wall Flashing** to the side and fit the first corrugated sheet peak into the flashing.



c

Lock the **CORRAPOL®-BT Rock n' Lock Wall Flashing** into place giving a waterproof and visually pleasing finish to the wall edge of your roof structure.

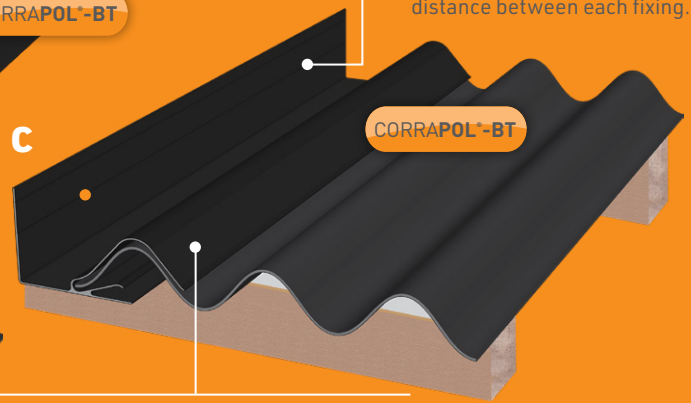

5

MEASURE and CUT the FIRST CORRAPOL®-BT roofing sheet

Measure, mark up the new length then cut off the excess roofing sheet with a lubricated universal bladed hand held saw allowing an **overlap eave of 70mm MAX.**

Cut all the remaining corrugated sheets to the correct length before starting the installation of your roof.

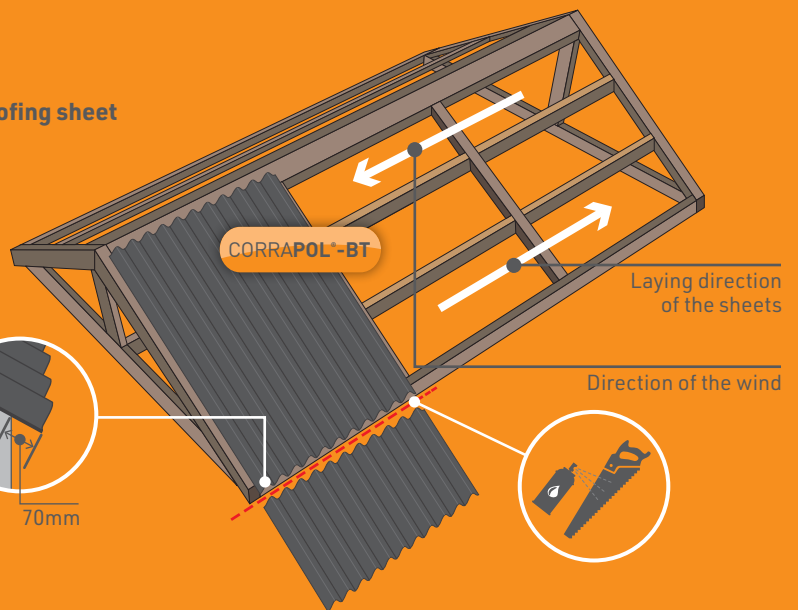

View Our How 2 Cut Corrugated Roof Sheets Video

6

Fix in place the CORRAPOL®-BT Foam Eaves Fillers onto every purlin

IMPORTANT - To keep the roof watertight and weatherproof, install **CORRAPOL®-BT Eaves Fillers** along every fixing point of the roof and **fix in place before installation of the roofing sheets.**

Make sure all the eaves fillers are aligned.

Repeat on the other side

For best performance and sealing install **CORRAPOL®-BT Foam Eaves Fillers** along the horizontal purlins and all fixing points of the roof. These will make installation easier, provide a stronger roof and give greater sealing properties from draughts etc.

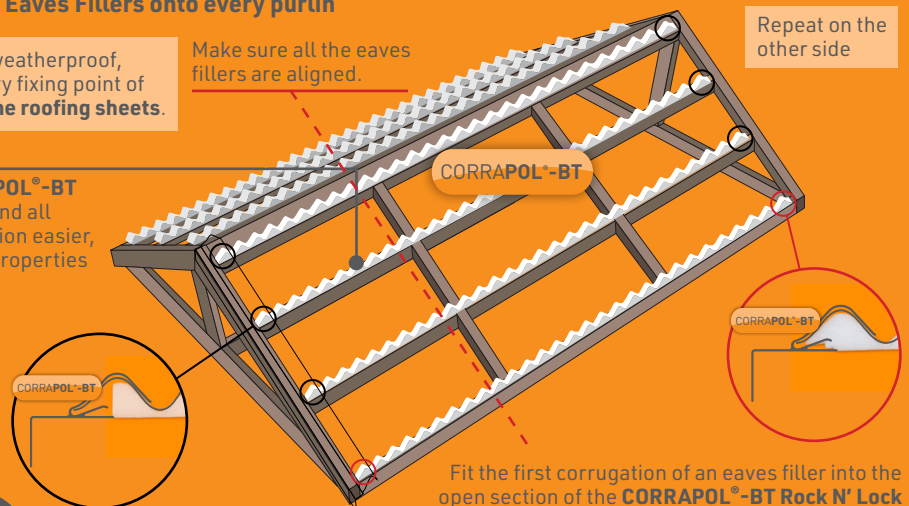

Fit the first corrugation of an eaves filler into the open section of the **CORRAPOL®-BT Rock N' Lock Gable Flashing** and **CORRAPOL®-BT Sheet** space.

7

Fit in place the **CORRAPOL®-BT Rock n' Lock Wall Flashing** and **FIRST Corrugated Sheet**

TOP TIP:

Use a **long straight edge/piece of wood** to mark up where to fix through the **CORRAPOL®-BT sheet** and the **foam eaves filler below** into the purlin.



When fixing **CORRAPOL®-BT** or **AWNAPOL®** sheets, the fixings should be **EVERY PEAK TOP AND BOTTOM** and **EVERY SECOND ON INTERMEDIATE PURLINS**.



NEVER THROUGH THE TROUGH

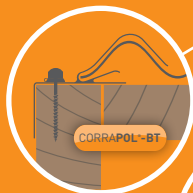

FIX EITHER through the top **OR** through the side of the bar.

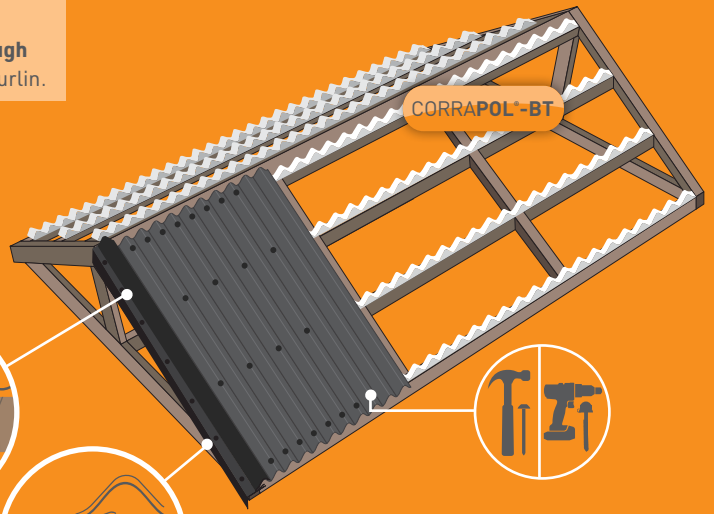
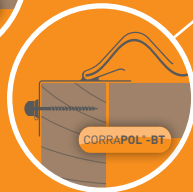

▶ View Our How 2 Fix Corrugated Roof Sheets Video

8

Prepare the **FINAL CORRAPOL®-BT roofing sheets** for both sides

Using the **Corrapol®-BT Rock N'Lock Gable Flashing** you should never need to make a vertical cut as there is flexibility on the width designed into the flashing.

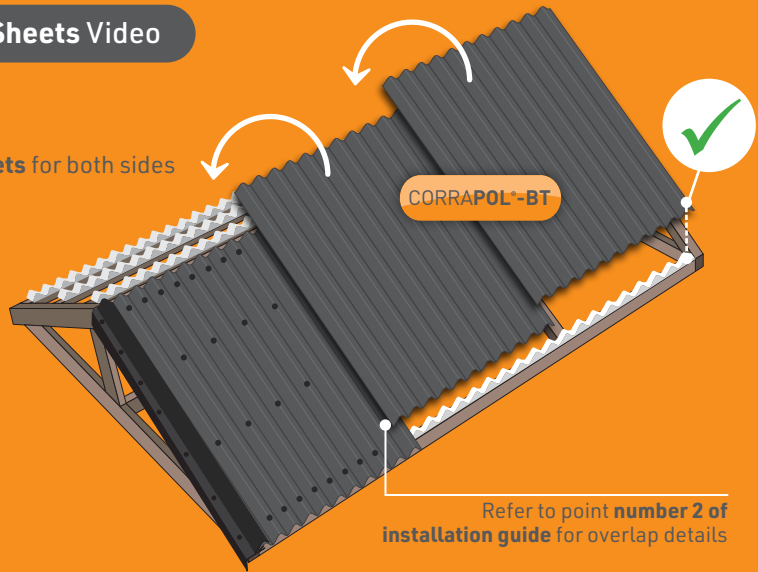

Refer to point **number 2** of **installation guide** for overlap details

9

Joining Sheets - end to end overlap example

JOINING SHEETS (END TO END):

If sheets need to be joined end to end, **ensure an appropriate overlap**, refer to details in **Step 2**.

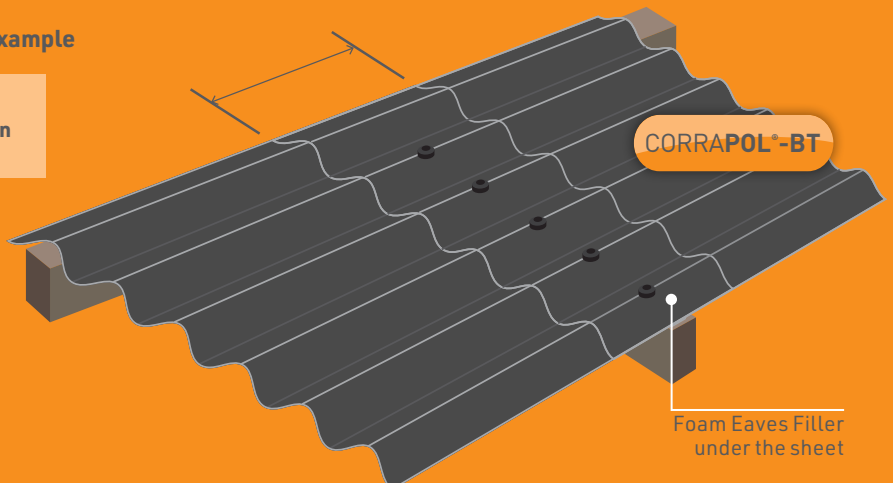

10

Fit the **CORRAPOL®-BT Rock n' Lock Gable Flashing** and **Corrugated Sheets**

Fit the remaining **CORRAPOL-BT Corrugate Sheets** plus **CORRAPOL-BT Rock n' Lock Gable** and **Wall Flashing** as shown in parts 3 and 4.



11

Install the **NEW CORRAPOL®-BT Super Ridge and End Caps**

Cut the aluminium **CORRAPOL®-BT Super Ridge** to the required length with the fine toothed bladed chop saw.

Pre-drill 5mm pilot holes approximately 250mm apart on the top of the **CORRAPOL®-BT Super Ridge**.

Slide the foam eaves filler into the two side slots of the **CORRAPOL®-BT Super Ridge** before installing onto the roof.

Fit the **CORRAPOL®-BT Super Ridge End Caps** onto either end of the **CORRAPOL®-BT Super Ridge** before fixing onto the peak of the roof.



Fill the small 2mm gap between the **CORRAPOL®-BT Ridge End Cap** and the **Super Ridge Bar** with **SECURBOND®** sealant to create a waterproof seal.



CORRAPOL®-BT Super Ridge section detail

Securbond Silicone/ flashing to create a waterproof seal

Fixings into the wall are not included

CORRAPOL®-BT Rock n' Lock Gable Flashing

Once the End Cap and Ridge Bar are fully sealed fit onto the peak of the roof

CORRAPOL®-BT Rock n' Lock Wall Flashing

Section view of the **CORRAPOL®-BT Super Ridge** and the **CORRAPOL®-BT Super Ridge End Cap**

WALL

12

Alternately install the **CORRAPOL®-BT Bitumen Ridge** panels

Use **nail or screw fixings** every two corrugation peaks

Overlap roof ridge panels by the minimum of 22cm

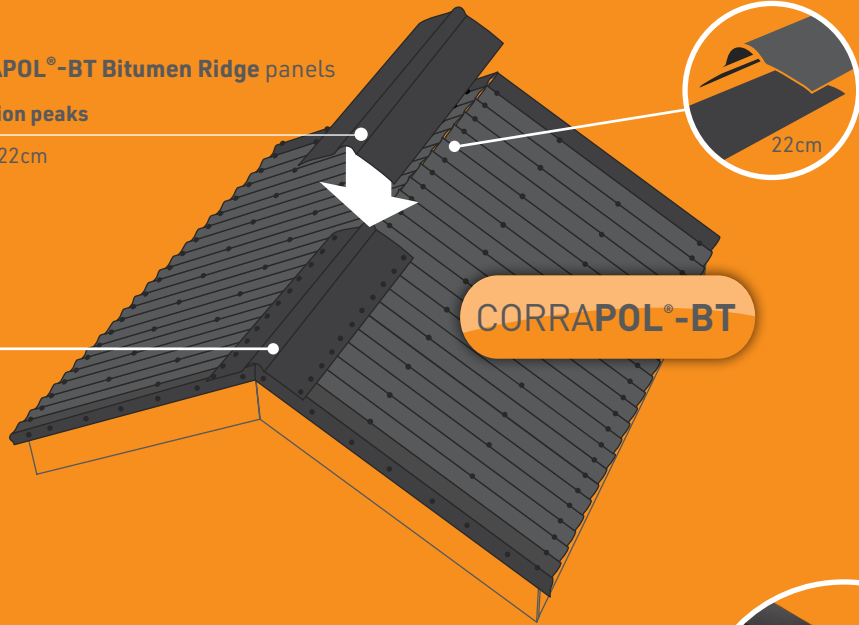

CORRAPOL®-BT

13

Finish of the back wall edge of a Lean-to roof using the **CORRAPOL®-BT Top Wall Flashing**



WARNING : REGISTERED DESIGNS & PATENTS

The IP of the designs in this brochure are protected by internationally registered design rights. Many products are also protected with active or pending Patents. Clear Amber will not hesitate to take appropriate legal action if its rights in this respect are infringed.

© Copyright – Clear Amber Group Ltd – September 2023. No part of this publication may be copied, reproduced, scanned, or stored in any electronic database, whether in whole or in part, in any form or by any means, without permission in writing from Clear Amber. Clear Amber will not hesitate to take appropriate legal action if its rights in this respect are infringed.

Inasmuch as Clear Amber have no control over the circumstances in which our material may be used, or site specific parameters, we cannot guarantee that any particular results will be achieved. Users should carry out their own tests to determine the suitability of the material for their application.