

ALUFLOW®

**Sustainable Affordable Quality
Aluminium Guttering System
Installation Guide**



ALUFLOW®

Patented and Registered Design

Your ALUFLOW® System:

Well done for choosing the Aluflow® Guttering and Downpipe System - The most Sustainable Affordable Quality guttering system available.

These Installation Guidelines walk you through each stage with step-by-step illustrations showing guidelines of best installation practices for Aluflow®.

We Are Here To Support You:

We understand that even with comprehensive Installation Guidelines, there can sometimes be a question that you can't find the answer to, so we're here to help you all the way. Visit www.clearamber.com and get in contact with our Help Teams via live chat, phone or email, who will be on hand to assist with any queries you may have.

Content:

<https://www.clearamber.com/browse/sc-ALUFLOWAluminiumGutteringSystem-467/>

Aluflow® Parts	3-4
Plan the Position of the Aluflow® Running Outlet	5
Fit the Aluflow® Gutter Brackets	6
Fit the Aluflow® Running Outlet and first length of Aluflow® Gutter	6
Prepare the Aluflow® Gutter Unions	7
Apply the Securbond® Sealant	7
Join the Aluflow® Running Outlet and the Aluflow® Gutter	8
Install the Aluflow® Gutter Union	8-9
Install the Aluflow® Stopped	9
Install the Aluflow® Internal and External Corners	9
Aluflow® Downpipe Installation	10

Aluflow® : Fast and Easy Installation

Below is a list of the core Aluflow® Aluminium Guttering Parts available.

IMPORTANT NOTE:



As with all aluminium products it is important to always use stainless steel fixings.

Aluflow® Gutter Bracket

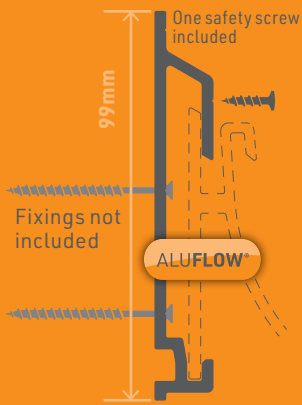

Aluflow® Deepflow Gutter

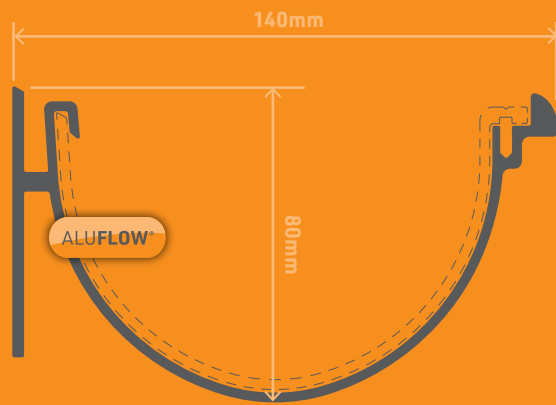

Aluflow® Deepflow Gutter Union

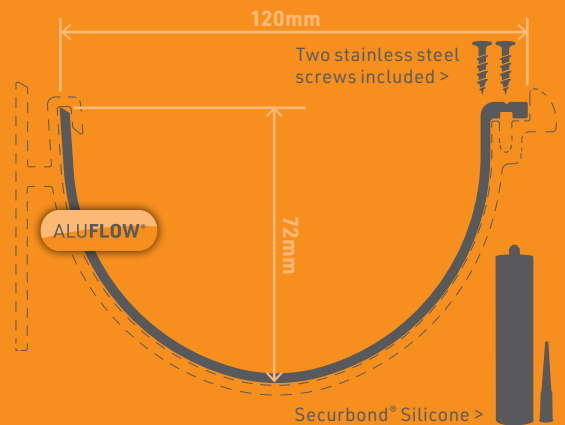

Aluflow® Downpipe Offset Bend - 112 Deg

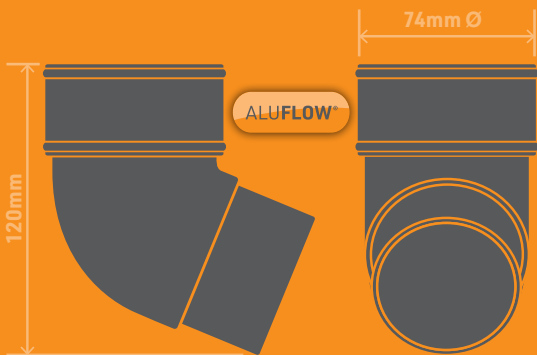

Aluflow® Downpipe Connector

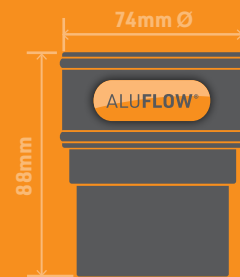

Aluflow® Downpipe Shoe

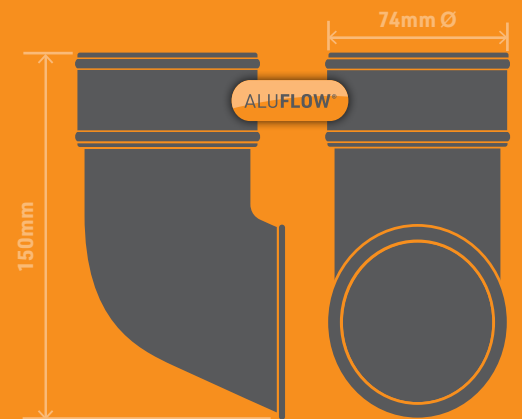

Aluflow® Downpipe



Aluflow® Downpipe Bracket

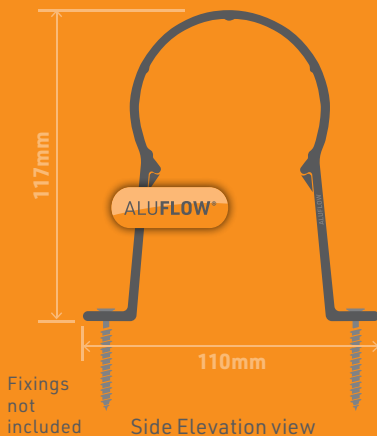

Aluflow® Deepflow Left and Right Hand Stopends

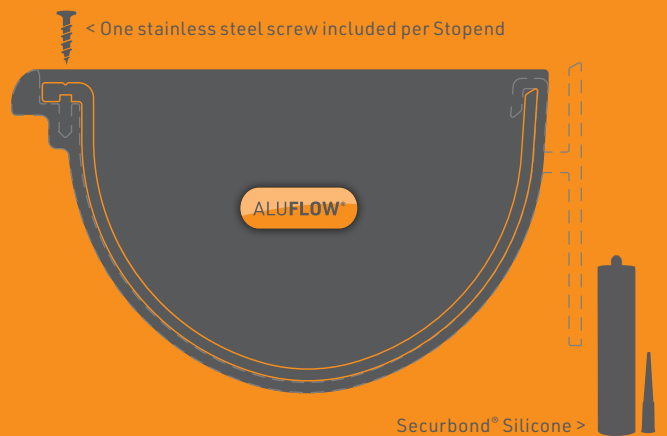

Aluflow® : Fast and Easy Installation

Aluflow® Running Outlet - Deepflow

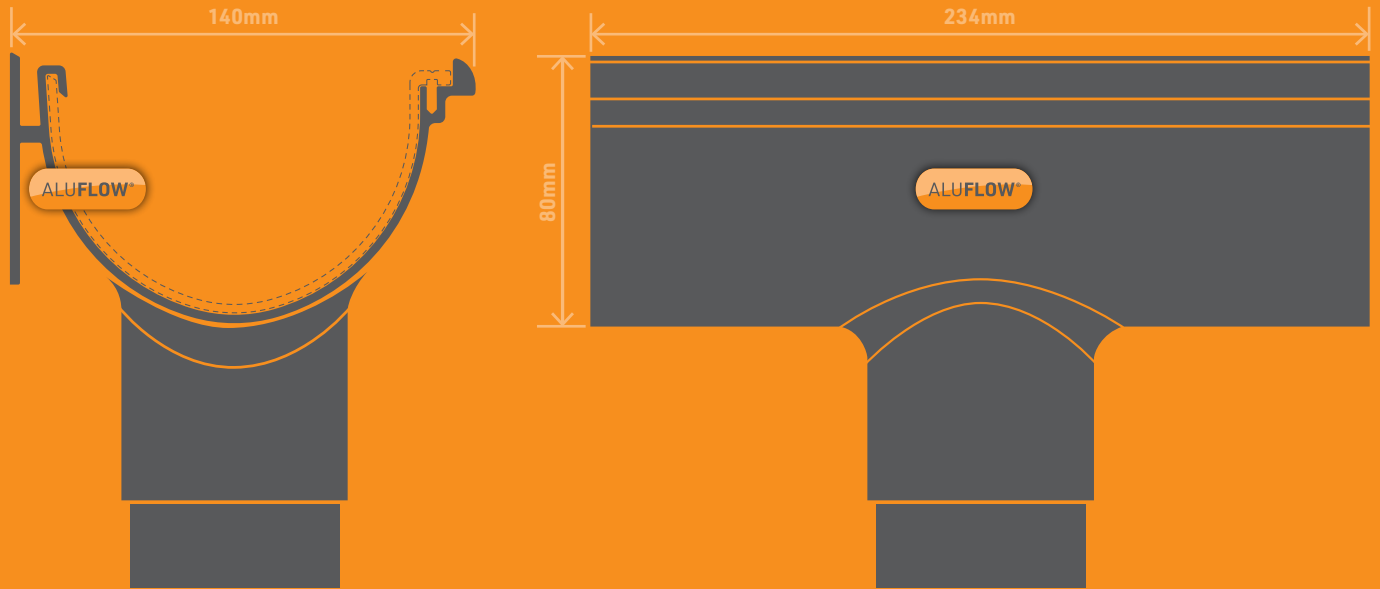

Aluflow® 90 Deg Internal Gutter Angle - Deepflow

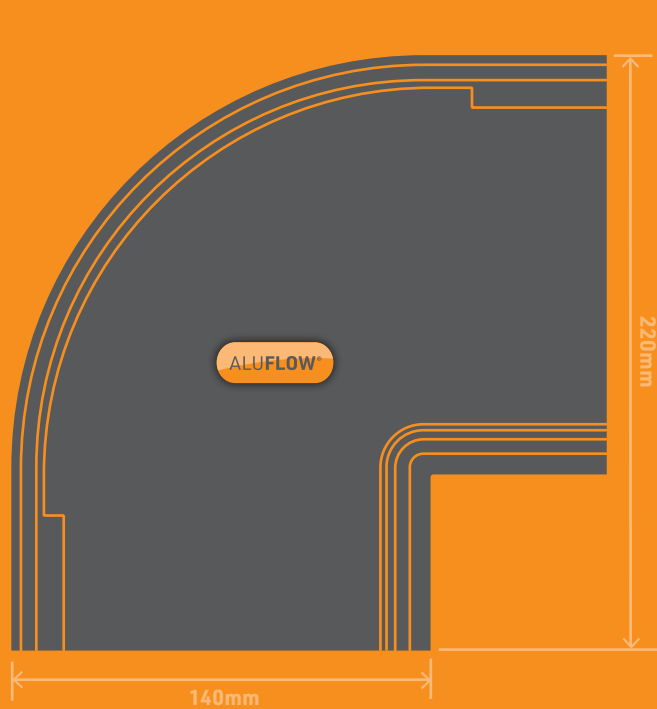

Aluflow® 90 Deg External Gutter Angle - Deepflow

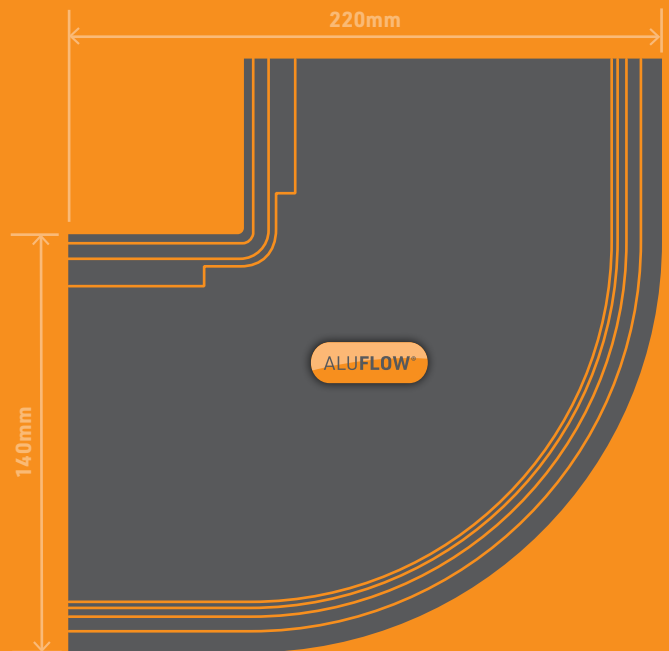

Tools and Sealant Required



Wear protective gloves, glasses and ear protectors where appropriate.



Tape measure and fine tooth blade chop saw

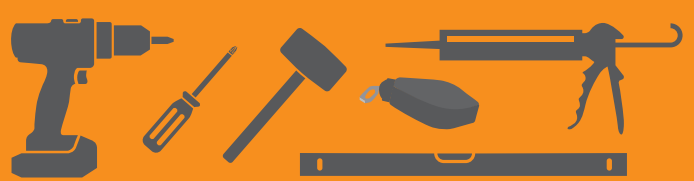

Cordless screwdriver/drill bits, Phillips headed screwdriver, soft rubber mallet, a straight edge tool, a chalk line, a knife and a **sealant gun loaded with Securbond® Silicone LMN sealant.**

IMPORTANT – Please ensure you take necessary safety precautions and checks before working at a height.

Aluflow® Installation

1 **START** at the running outlet

2 **CHOOSE** the correct level for the gutter bracket

Choose the correct level for your gutter bracket ensuring the line of the rain water flows straight into the gutter.

3 **MARK** the height of the gutter brackets on the fascia

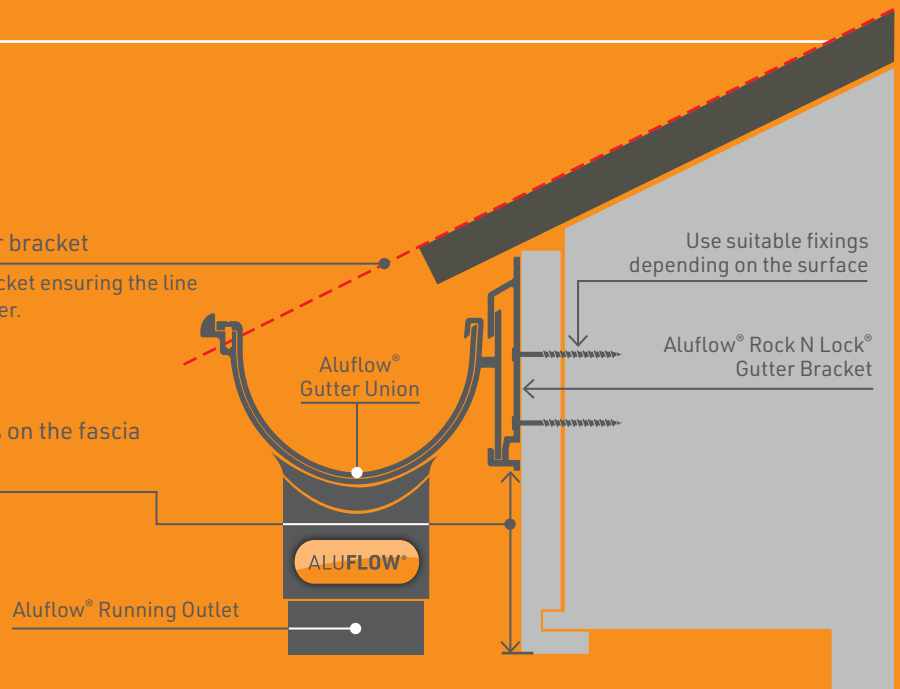

4 Run a stringline/ chalk line from the height mark to create a level line in both directions

5 Decide where your running outlet is going and mark the centre point from the opening of the outlet

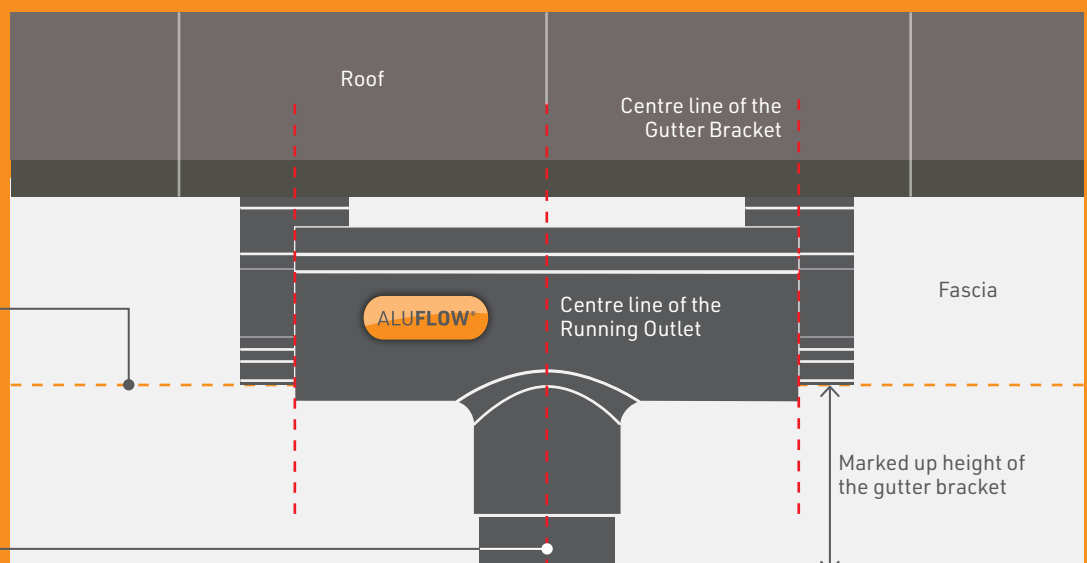

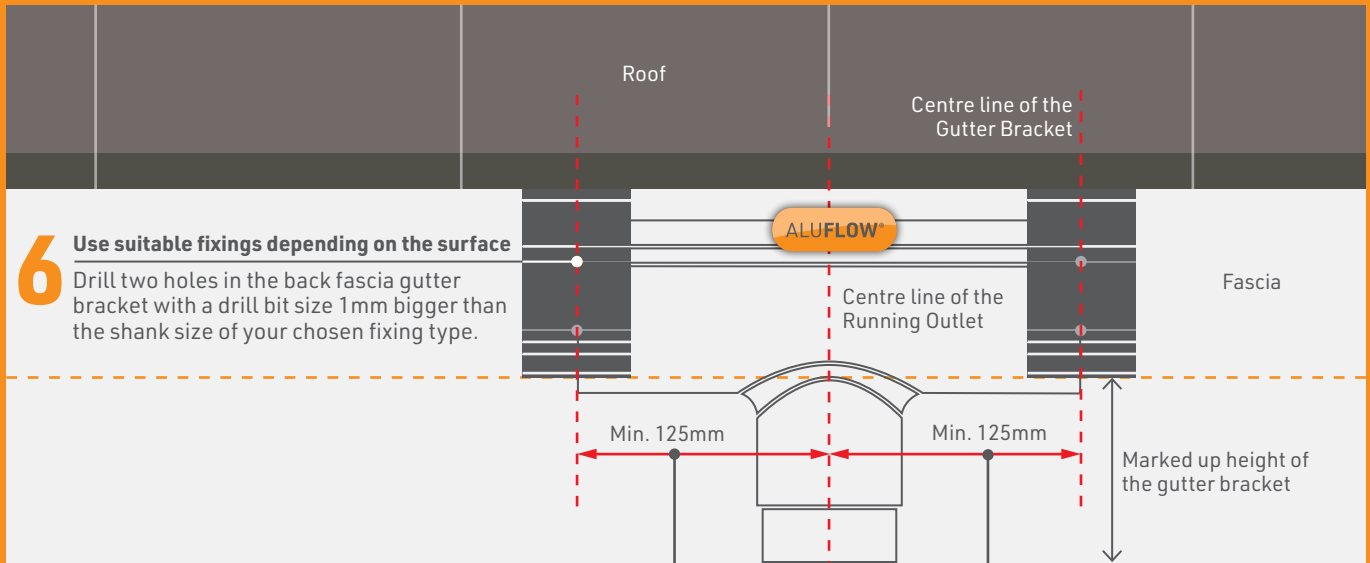

6 Use suitable fixings depending on the surface
 Drill two holes in the back fascia gutter bracket with a drill bit size 1mm bigger than the shank size of your chosen fixing type.

7 Measure 125mm from the centre of the running outlet centre line in both directions and install the first gutter brackets

8 Securely fix the intermediate gutter brackets at 600mm centres to the fascia along the level line

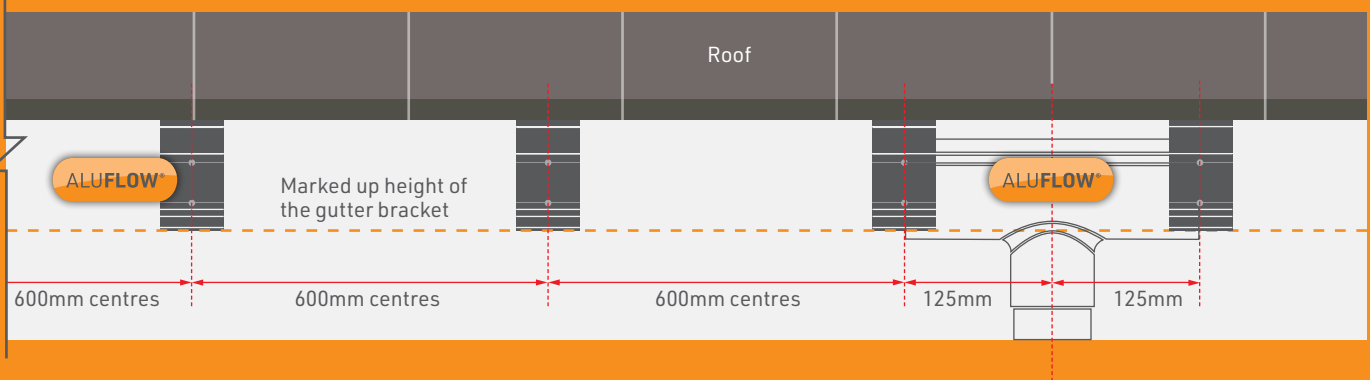

9 Rock N Lock® the Running Outlet and first length of Gutter onto the Gutter Brackets

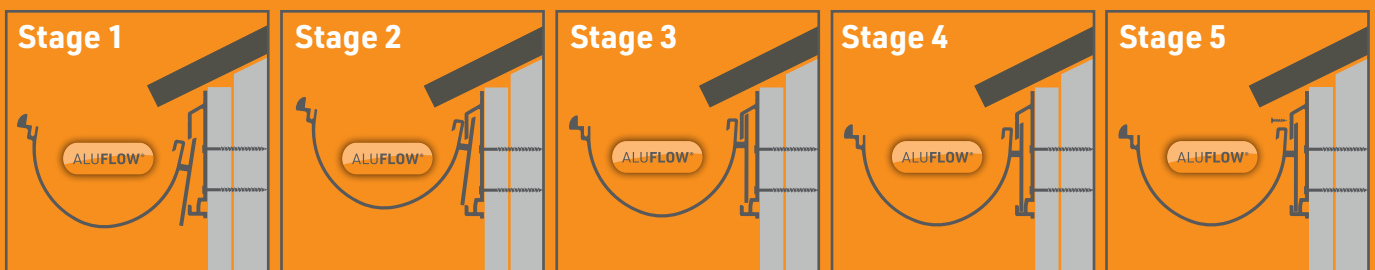

Stage 1
 Tilt the AlufLOW® Gutter forward and slip the back plate into the top hook of the AlufLOW® Rock N Lock® Gutter Bracket.

Stage 2
 Lift the AlufLOW® Gutter up into the bracket to clear the bottom hook of the AlufLOW® Rock N Lock® Gutter Bracket.

Stage 3
 Lower the front edge of the AlufLOW® Gutter to level it up so that the back plate of the Gutter is directly above the AlufLOW® Rock N Lock® Gutter Bracket channel.

Stage 4
 Lower the AlufLOW® Gutter to lock in to the AlufLOW® Rock N Lock® Gutter Bracket.

Stage 5
 Drill a 3.5mm hole at the top of AlufLOW® Rock N Lock® Gutter Bracket where the small groove indicates and screw in the AlufLOW® Rock N Lock® safety screw.

10 PREPARE the Aluflow® Gutter Union for installation

Take the Aluflow® Gutter Union, measure 25mm in from each end along the screw fixing line and **drill a hole with a 3.5mm drill bit at these points.**

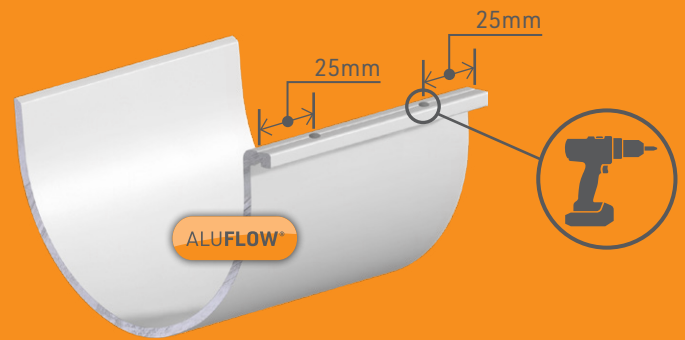

11 PREPARE the Securbond® Silicone prior to installation

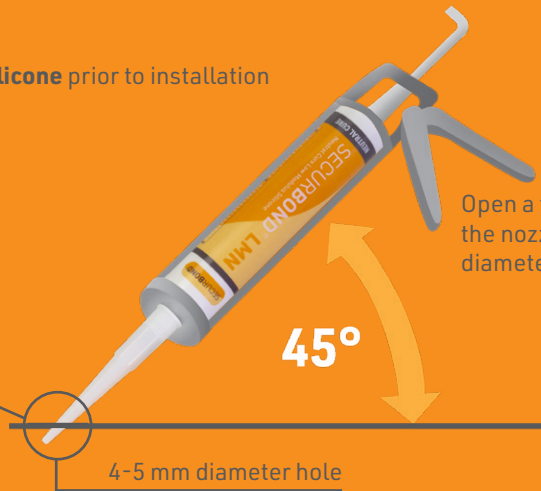
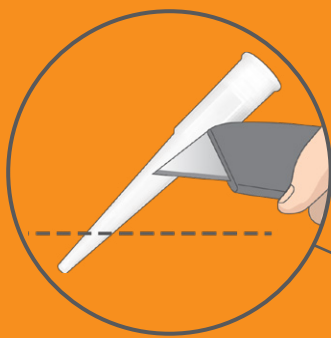

Open a tube of Securbond® Silicone and cut the nozzle to a 45 degree angle to a 4-5 mm diameter hole then insert into silicone gun.

12 MEASURE the POSITION where the sealant will be applied

Ensure the internal surface of the gutter is free of dirt, swarf and dry.

Measure the back and front edges of the gutter measuring **APPROX 20mm and 40mm from the end of the gutter or fitting.**

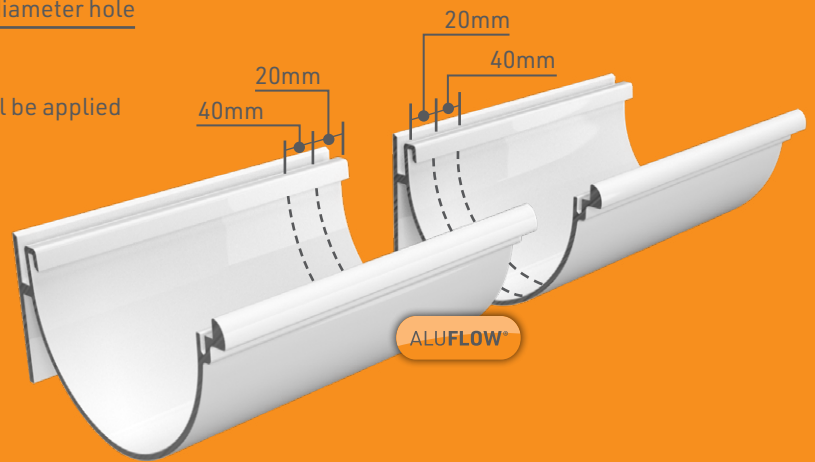

View Our How 2 Join Aluminium Guttering Video

13 APPLY the SECURBOND® sealant to the Aluflow® Gutter

Run two fine beads of Securbond® Silicone around the **inside surface of the gutter from the front to the back.** Make sure there are no gaps in the silicone bead from front to back of the internal surface of the gutter. Repeat the procedure on the adjoining running outlet.

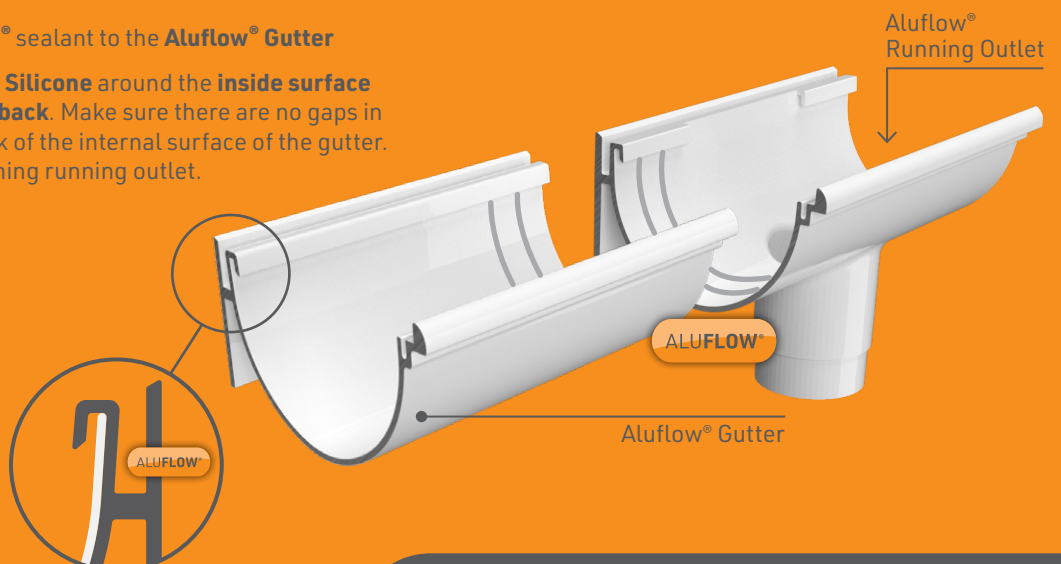
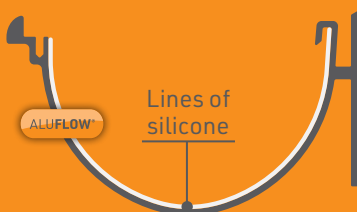

14 Make sure the **GUTTER LENGTH** and **RUNNING OUTLET** are butted tightly together



15 SEAL the **FIXING CHANNEL** 50mm IN BOTH DIRECTIONS where the union will be screwed into.

You should now have four parallel beads of sealant on either side of the joint area.

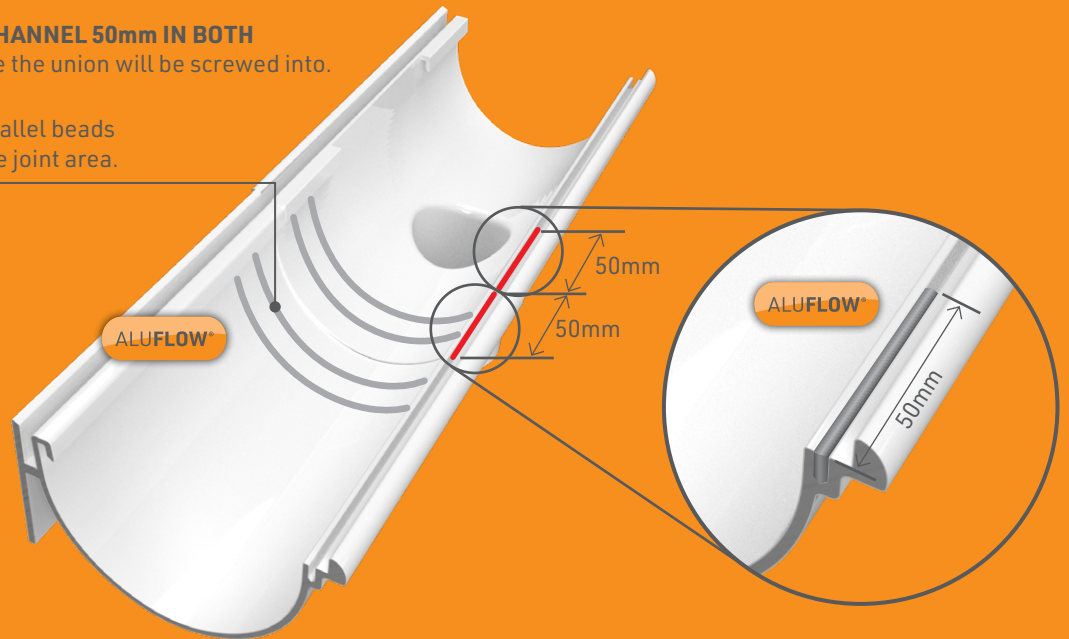

16 Take **TWO SMALL SCREWS** and thread them partially through the holes in the Aluflow® Gutter Union - ensure the union is clean and dry.

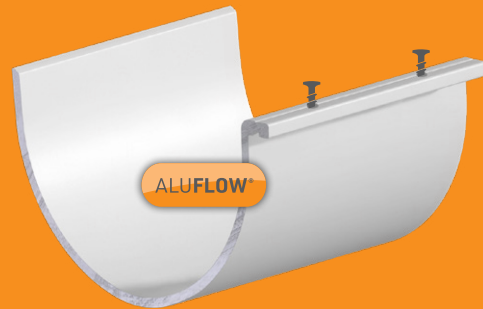

17 LOWER and fit the Aluflow® Gutter Union into place

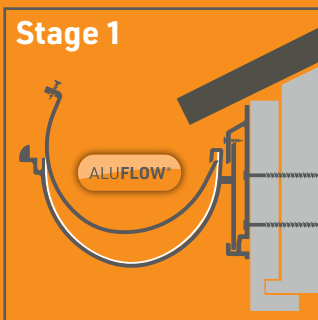

Lower the far edges of the union (the far side from the screws) and hook the back part of the union into the slot at the side.

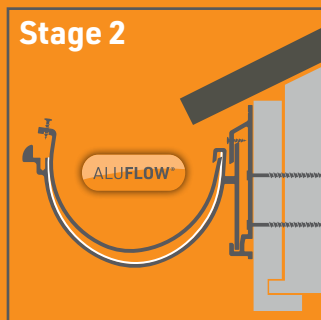

Lower the far edge down to squash into the silicone.

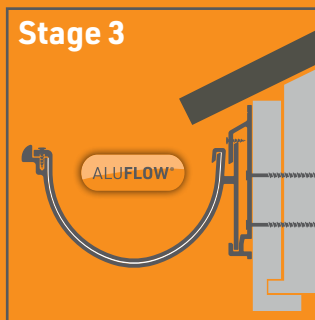

Screw the 2 screws in to both sides of the union until firmly fixed.

17

LOWER and fit the **Aluflow® Gutter Union** into place (continued)

Your silicone beads should ooze out of either side of the union.

Leave excess silicone as it is for now, for any silicone on the underside allow it to dry then cut off 24 hours later.

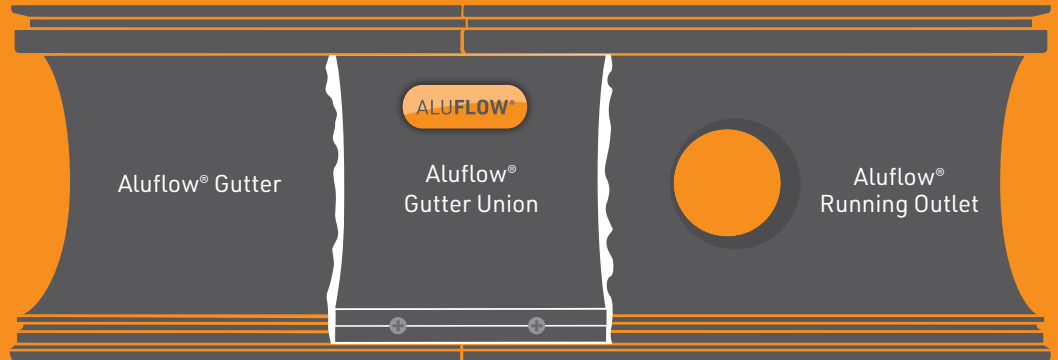

18

Continue to install the rest of the **Aluflow® Guttering** and **Aluflow® Stopends**

IMPORTANT – Cut the lengths of the gutter accurately to fit between any corners and running outlet positions.

Continue to install the lengths of **Aluflow® Gutter** in the same way to the end of the gutter run then install the **Aluflow® Stopend** into the end of the final piece of gutter.

This is installed the same way as the **Aluflow® Gutter Union**, refer to step 17.



19

Aluflow® Internal Corner fitting details

Fix first bracket 235mm out from the corner to the centre of the bracket in both directions. Rock N Lock® the internal corner into the 2 brackets now fitted.



20

Aluflow® External Corner fitting details

Fix first bracket 80mm out from the corner to the centre of the bracket in both directions. Rock N Lock® the external corner into position into the two fitted brackets.



20 Aluflow® Downpipe Installation

- 1 Measure from the top of the **Aluflow® Running Outlet Pipe Slot pipe** down to the bottom of your fascia. Cut a small piece of **Aluflow® Downpipe** to this length.
- 2 Fix the **Aluflow® 112 Deg Offset Bend** (Ensure the female end is at the top).
- 3 Measure the **Aluflow® Downpipe** length between the two offset bends allowing for the 35mm insertion section at either end of the Aluflow® Downpipe.
- 4 Follow the angle through and then fit the other **Aluflow® 112 Deg Offset Bend** (Ensure the female end is at the top) with an Aluflow® Downpipe Bracket (5) to the wall.
- 5 Ensure the **Aluflow® Downpipe Bracket** is secured firmly, preventing any movement of the offset bends or pipe pieces. Additional Aluflow® Downpipe Brackets should be used to ensure there are no loose parts.
- 6 Cut a piece of **Aluflow® Downpipe** to fit between the lower Aluflow® Offset Bend (4), the Aluflow® Downpipe Connector (8) (if required) and the Aluflow® Downpipe Shoe (9).
- 7 Secure with **Aluflow® Downpipe Brackets** (5) and (7)
- 8 To extend the length of the Aluflow® Downpipe fit the **Aluflow® Downpipe Connector** between lengths (if required).
- 9 Fix the **Aluflow® Downpipe Shoe** so that the rain water deflects away from the building and into your drain.

Points 2, 4, 8 and 9

It is also recommended that you use **Securbond® Sealant** between the Aluflow® Downpipe, Aluflow® 112 Deg Offset Bend and Aluflow® Downpipe Connector connections for the perfect seal.

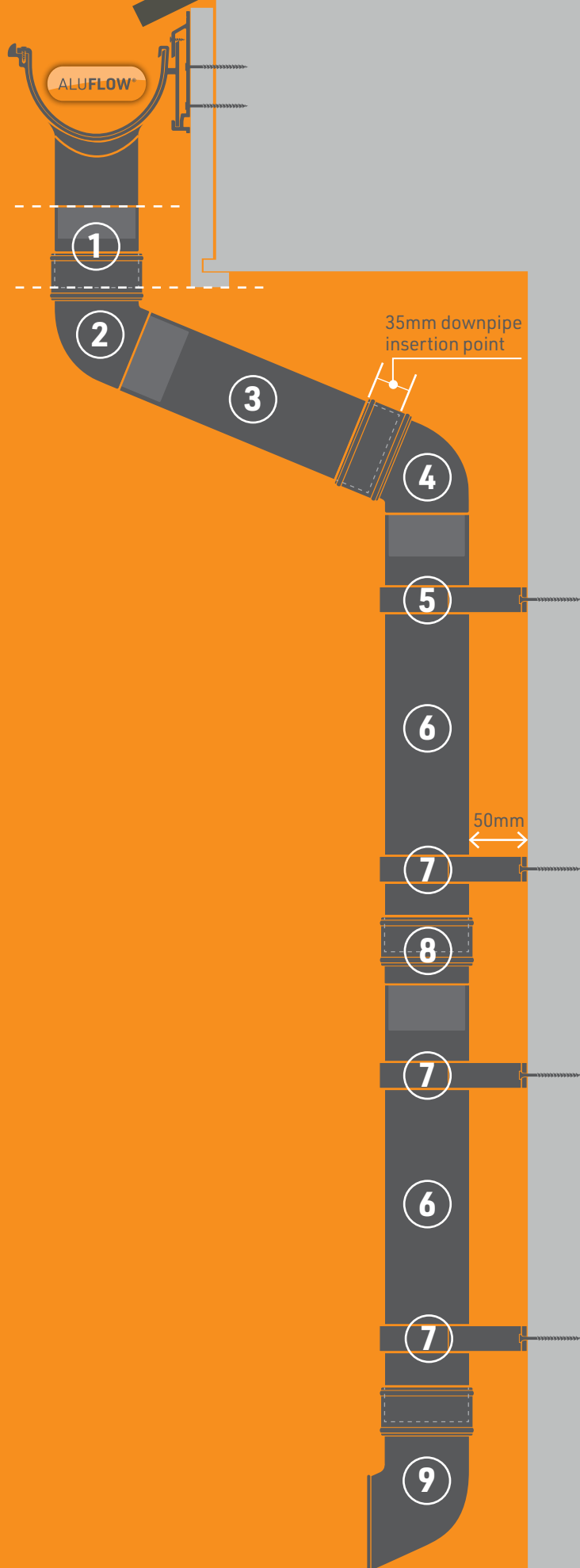

Aluflow® Disclaimer:

Aluflow® products are powder coated to closely matched RAL codes within industry accepted tolerances. However please note that the varying manufacturing processes of different items such as the substrates, application methods and paint conditions can lead to slight variations in colour and satin-level finish. Additionally, the finished colours may differ from batch-to-batch. Therefore there may be shading and satin-level differences between different components which is an accepted phenomenon.

WARNING : REGISTERED DESIGNS & PATENTS

The IP of the designs in this brochure are protected by internationally registered design rights. Many products are also protected with active or pending Patents. Clear Amber will not hesitate to take appropriate legal action if its rights in this respect are infringed.

© Copyright – Clear Amber Group Ltd – December 2023. No part of this publication may be copied, reproduced, scanned, or stored in any electronic database, whether in whole or in part, in any form or by any means, without permission in writing from Clear Amber. Clear Amber will not hesitate to take appropriate legal action if its rights in this respect are infringed.

Inasmuch as Clear Amber have no control over the circumstances in which our material may be used, or site specific parameters, we cannot guarantee that any particular results will be achieved.

Users should carry out their own tests to determine the suitability of the material for their application. Installers should satisfy themselves that published permissible loadings and spacings for the Aluflow® guttering system, together with any supporting posts, frames, or walls and fixings, are sufficient to provide adequate strength for the intended use and to meet regional loading requirements. Installers should also obtain their own job-specific structural engineer's report for their individual site. Samples are readily available to users to test and verify the exact sizes according to their site requirements.