



# INSTALLATION GUIDE



## COMPOSITE FENCING



  
**ECOSCAPE**<sup>®</sup> **UK**  
[www.ecoscapeuk.co.uk](http://www.ecoscapeuk.co.uk) | 0845 9011 988

Fencing Installation Guide (Revised Apr 2022)

# CONTENTS

STORAGE AND HANDLING	03
SAFETY AND USE	04
TOOL	05
CALCULATING MATERIAL	06
COLOURS AND EFFECTS	07
FENCING COMPONENTS OVERVIEW	08
FENCING COMPONENTS	09
FENCING COMPONENTS CONT	10
INSTALLATION METHODS	11
INSTALLATION - IN GROUND OR GRASS	12
INSTALLATION - TO CONCRETE FOOTING OR BLOCK WALL	21
INSTALLATION - (OPTIONAL) POST CAPPING BOARD	25
INSTALLATION - RETROFIT	27
CLEANING AND CARE	28

# STORAGE & HANDLING

Whilst our composite materials are highly durable we do recommend you follow the below guidelines for storage, handling and installation, to ensure products are kept in the

## STORAGE

- Materials should be stored under cover in shade, and protected from weather until ready to install.
- Materials should be covered and kept dry until ready to install to ensure a clean surface. Products should not be stored outside and / or covered with plastic sheeting.
- All composite products should be stored supported above the ground at 500mm intervals on a flat clean surface. Supporting battens used in storage should align through the stack to equally transfer the load.
- Fencing panels must be stacked on top of each other.
- Where multiple pallets are delivered these should not be stacked higher than 3m per stack.
- Ecoscape will not be held responsible for any issues that arise from poor storage.

## HANDLING

- Fencing boards should be lifted and set down with care to avoid damage. Do not slide boards over one another.
  - Fencing boards should be carried in the middle and on their edge for best support when moving.
  - Avoid sliding or dragging any equipment across the board surface to avoid tarnishing the surface.
  - The surface of the fencing boards should be kept free of construction debris and material to prevent damage to the boards.
- As with all sites, surfaces should be kept clean and tidy for the best installation outcome.

# SAFETY & USE

Prior to installing any composite system we recommended that you consult local building regulations for any special requirements or restrictions that may apply. The illustrations and accompanying instructions in this guide are for illustrative purposes to provide a typical installation scenario, and do not replace the advice of a licensed professional in the field.

## SAFETY

- Personal Protection Equipment (PPE) should be worn at all times (COSHH Assessment summary available). When cutting and installing boards it is advised to wear gloves, protective eye wear, a dust mask, long sleeves and trousers.

- Dry and windy environments may result in a naturally occurring static build-up in composite products. The level of static build up will not cause personal injury.

## USE

- Standard tools can be used to install our composite fencing. When using a chop saw we would recommend a 60T+ Multipurpose Aluminium blade for maximum efficiency and neatness on cuts.

- Plan a layout for your fencing before starting to ensure the best looking layout is achieved.

# TOOLS

## RECOMMENDED TOOLS TO INSTALL ECOSCAPE COMPOSITE FENCING SYSTEM

Standard woodworking/fencing tools can be used when working with Ecoscape Composite Fencing. If you are unsure on how to use any tool, please consult the tool's

Stringline

Tape measure

Spirit Level

Hole digging equipment

Hand saw / Mitre Saw.

Protective eye wear and relevant Personal Protection Equipment (PPE)

Pencil

Not essential but useful – Laser level and Post hole digger

Electric drill and cordless screwdriver when installing the fence base plates (and the optional fence capping board)

# CALCULATING MATERIAL

To determine how much Ecoscape Fencing material will be required, you can either use detailed plans and elevations, or follow the method below.

## Step 1. Measure the length and height of your fence.

To work out how many fence boards you will need divide the length of the fence / 1905mm. This measurement is the total width of a panel including the centre of posts as illustrated

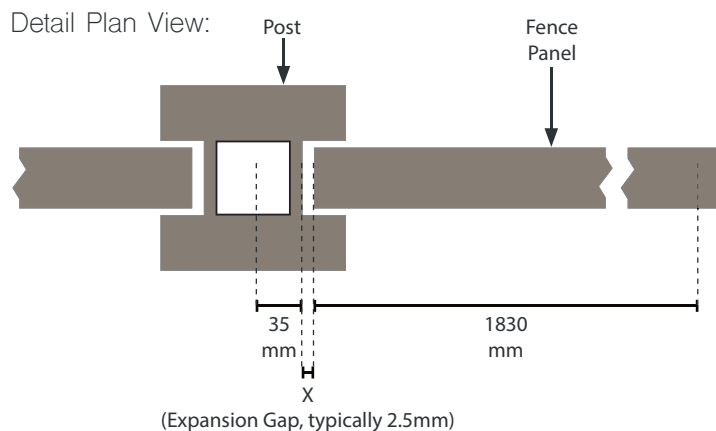
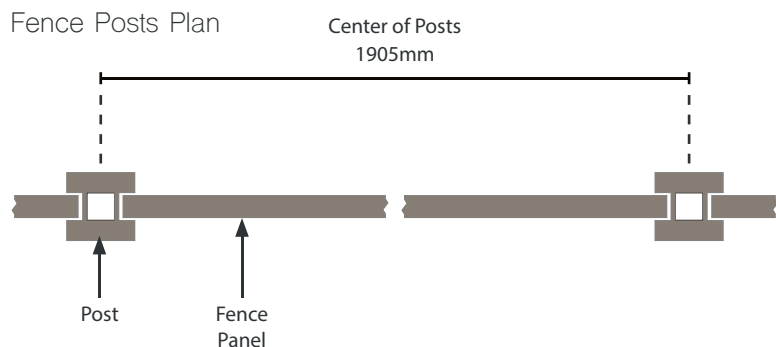

Note: As shown on the diagram adjacent, the set out of the fence boards includes a expansion gap to the end of the board (X). This accounts for minor expansion of the board during hot weather.

The expansion gap value (X) should be as follows:

Air Temperature at time of installation	Expansion Gap (X)
0 degrees	4mm
10 degrees	3mm
20 degrees	2mm
30 degrees	1.5mm

Note - If required the fence posts can be cut to length using standard woodworking tools or account for the expansion gap if required.

## Step 2. Calculate the height

Fence boards are 1830mm in length x 157mm in height but have a finished face of 150mm.

Below is a list showing the number of standard Fence Boards (excluding Aluminium Bottom Rail (45mm assembled height) + top fence board 140mm assembled height =185mm) needed to achieve a certain height, based on stacking the boards on top of each other horizontally:

- 11no. Boards = 1650mm (+185mm) = 1835mm (approx. 6ft)
- 9no. Boards = 1350mm (+185mm) = 1535mm (approx. 5ft)
- 7no. Boards = 1050mm (+185mm) = 1235mm (approx. 4ft)
- 5no. Boards = 750mm (+185mm) = 935mm (approx. 3ft)

(Area of 1no. Fence Board = 157 x 45 x 1830 = 0.28 m<sup>2</sup>)

## Typical Example:

If your boundary fence is 14 meters long, 1.8m (6ft) in height, and you're installing on a 15 °C day:

Length 14m / 1905mm (Board length, expansion gap and post widths)  
= 7.34 sections

Number of Fence boards needed - 7 x 11 = 77

For the 0.34 section of a panel, you will get two fence boards out of one length - so another 6 fence boards needed for the cut section.

Total Needed:

Standard Fence Boards = 83

Posts = 9

Post Caps = 9

Aluminium Bottom Rail = 8

Top Fence Board = 8

Plastic Clip = 16

Ecoscape composite fencing range offers end, inter and corner posts. Which posts used depends on your project.

If you need any further help please call/ email on 0845 9011 988 or sales@ecoscapeuk.co.uk

# COLOURS AND EFFECTS

Ecoscape Composite Fencing is available in 5 colours, and is dual sided to allow a range of effects to be achieved:

## AVAILABLE COLOURS

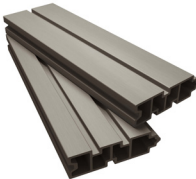

SILVER BIRCH



SPICED OAK



CHARCOAL



GRAPHITE



WALNUT

## POSSIBLE FINISHES

(PLUS MORE!)

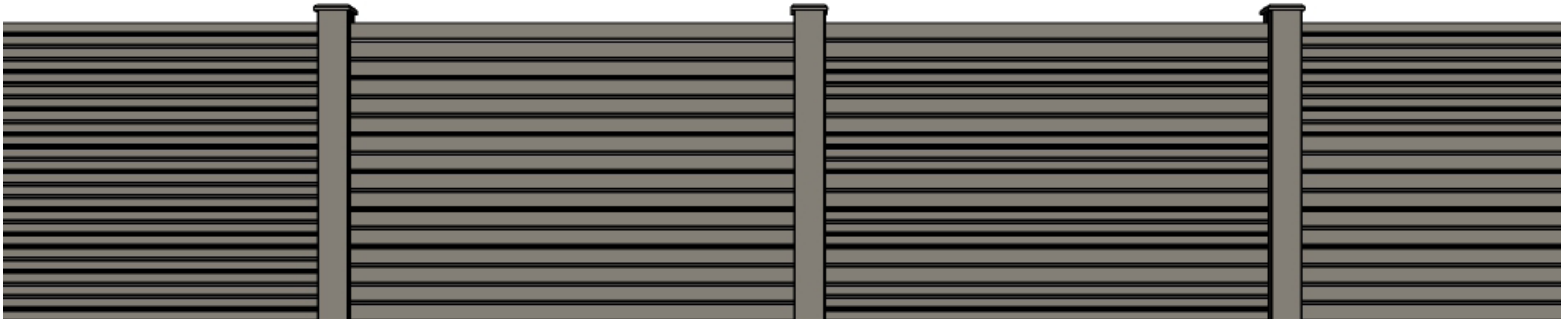

38mm  
Panel Side

63mm  
Panel Side

Interchanging 38, 63mm  
Panel Sides

63mm, 38mm Header  
Panel Sides

# FENCING COMPONENTS OVERVIEW

The diagram below give an overview of the fencing components.

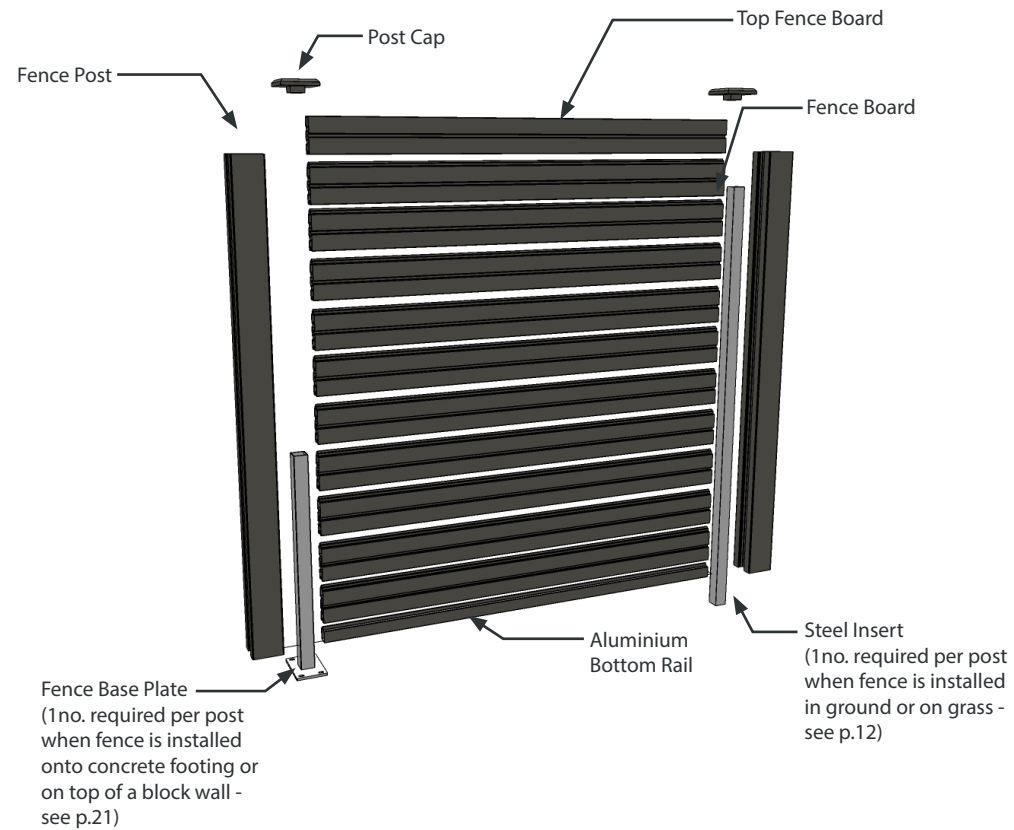



# FENCING COMPONENTS

Please ensure you are familiar with all the fencing components prior to

Fence Board  
(45 x 157 x 1830mm)\*\*

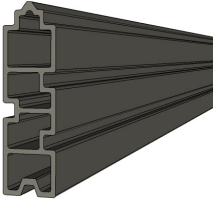

Intermediate Fence Post  
(125x125x1940mm)\*\*

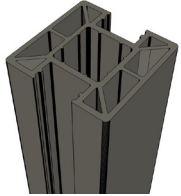

End Fence Post  
(125x125x1940mm)\*\*

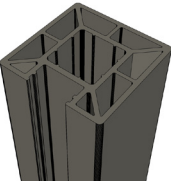

Corner Fence Post  
(125x125x1940mm)\*\*

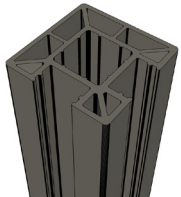

Top Fence Board  
(45x138x1830mm)\*\*

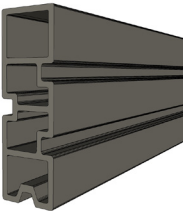

Aluminium Bottom Rail  
(45x52x1830mm)\*\*

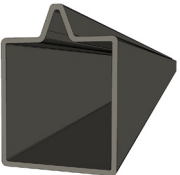

\*\*Available in colours: Charcoal, Graphite, Walnut, Silver Birch & Spiced Oak

# FENCING COMPONENTS

## CONT.

Post Cap  
(145 x 145 x 23mm)\*\*

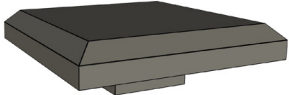

Plastic Security Clip / Support for  
Aluminium Bottom Rail (optional)  
  
(Supplied as pack of 2)

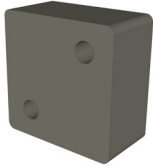

Security Nail (Self Tapper)



Steel Insert  
(55x55x1940mm)  
  
(Concreted into the ground)

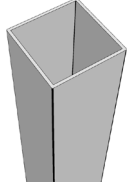

Fence Base Plate (Steel)  
(125x190x900mm)  
  
(Fix to Concrete / Masonry)



Base Plate Fixing Bolts and Caps  
(M10x80mm)  
  
(Fix to Concrete / Masonry)



\*\*Available in colours: Charcoal, Graphite, Walnut, Silver Birch & Spiced Oak

# INSTALLATION METHODS

There are 3 main methods to installing Ecoscape Composite Fencing:

1.

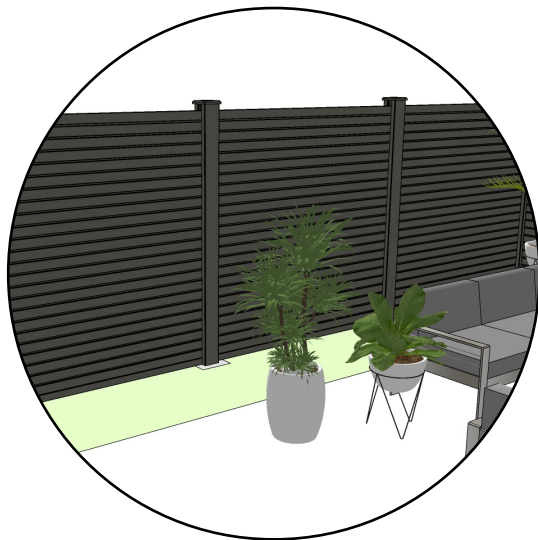

Into ground or grass - with a concrete footing

2.

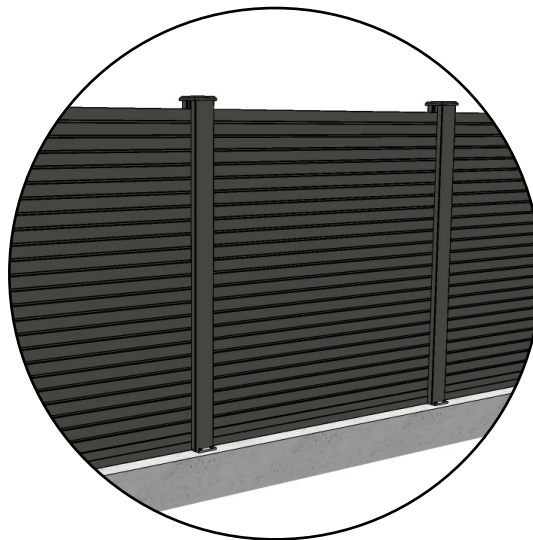

Onto a concrete foundation or brick wall

Please refer to page 21

3.

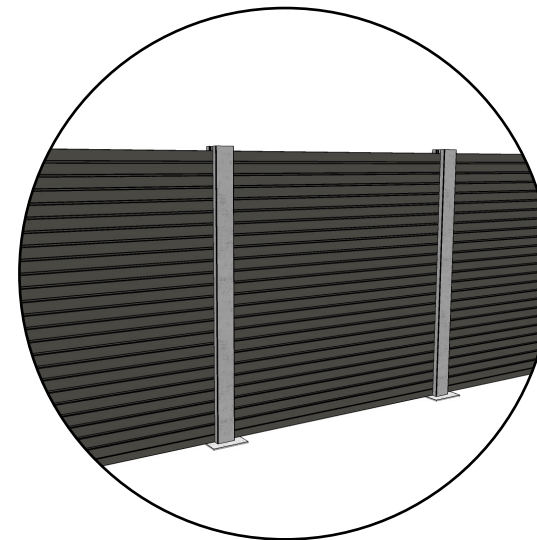

Retrofit - Into existing concrete posts

Please refer to page 25

# INSTALLATION - IN GROUND OR GRASS

## STEP 1

### MARK OUT THE FENCE LINE AND DIG HOLES

- A Use a stringline to mark out the line of the fence. Make sure the area is clear of any obstacles/vegetation.

Please note that your posts should always be on your side of the boundary.

A

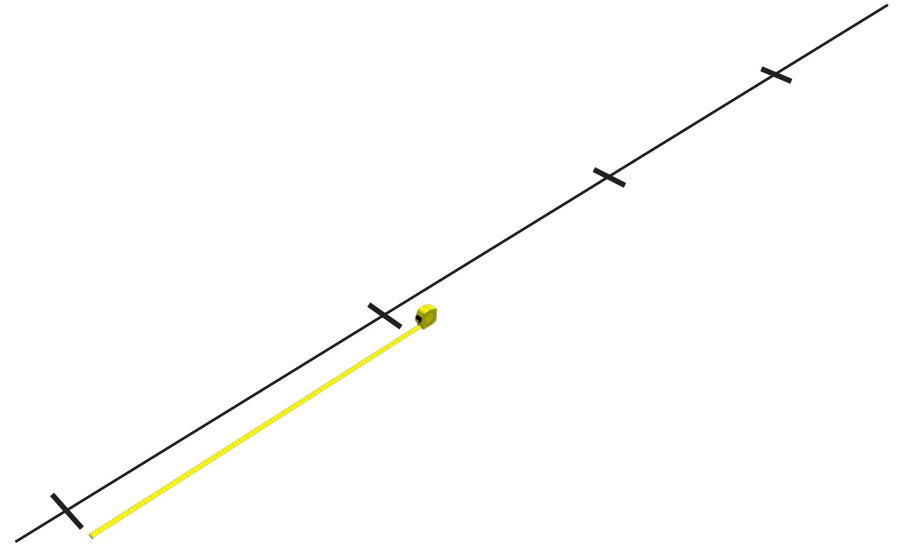

- B Dig a hole using a narrow shovel or Fencers graft to a depth of 600–850mm depending on the softness of the ground.

Ensure the base of the pit is level.

B

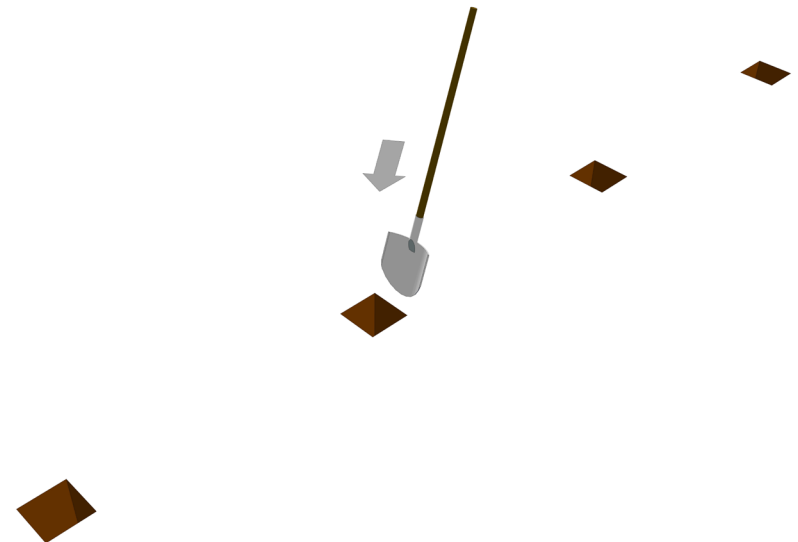

# INSTALLATION - IN GROUND OR GRASS

## STEP 2

### SET THE FIRST STEEL INSERT IN CONCRETE

C Place the steel insert in the hole and ensure it is level using a spirit level. We recommend getting a second person to help you do this.

C

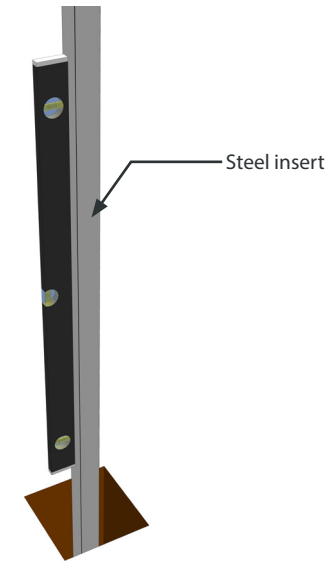

D Fill the hole with post mix concrete. We recommend 2.5-3 no. 20k bags depending on the size of the hole and ground conditions. Ensure that the concrete is filled to around 25mm below the soil / ground level. Also ensure that concrete is angled away from the fence post to aid water run off

D

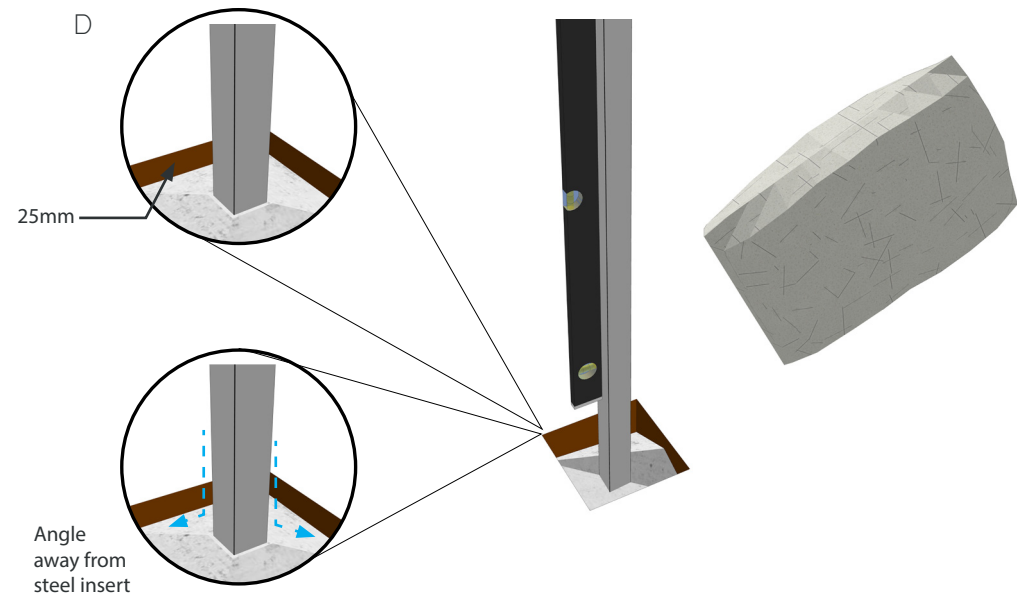

# INSTALLATION - IN GROUND OR GRASS

## STEP 3

### ENSURE THE POST IS LEVEL AND SET OUT THE NEXT

- E Place the Composite fence post over the steel insert. Check once more to make sure the post is plumb and level. Brace if needed – but avoid screwing into the composite post. After 24hrs support braces can be removed, once the concrete has set.

Please note – The composite fence post is to sit on-top of the concrete. Only the steel insert is concreted into the ground. Whilst the concrete is setting, ensure the post does not rest on the surface – use temporary battens if necessary.

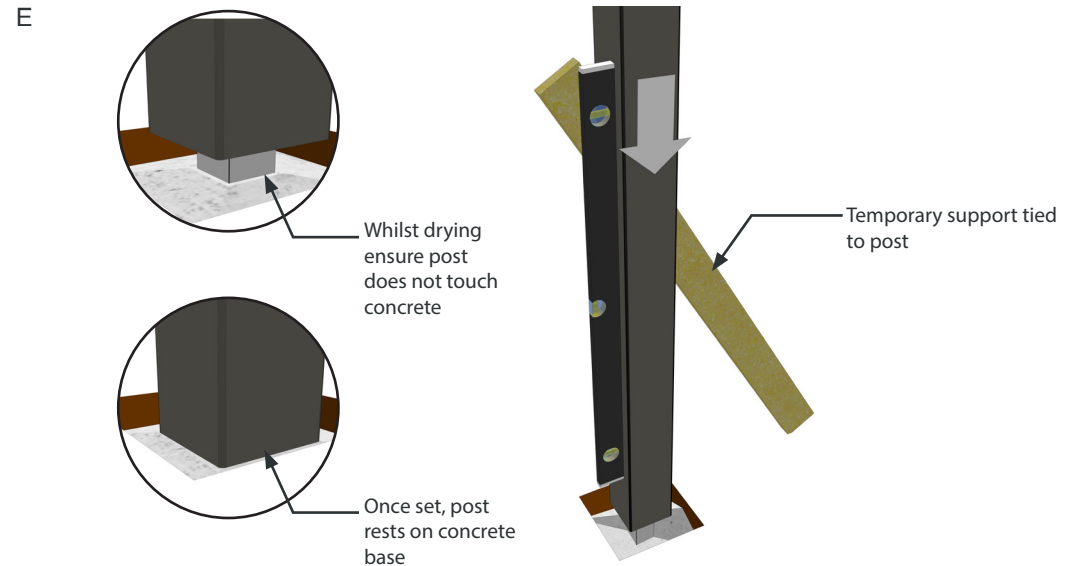

- F Use a string line to set out the next post and measure the distance to ensure correct.

It can be useful here to use the Aluminium Bottom Rail (Refer to step 5), to double check the distance and set out. Be careful to not get any wet concrete on the rail itself.

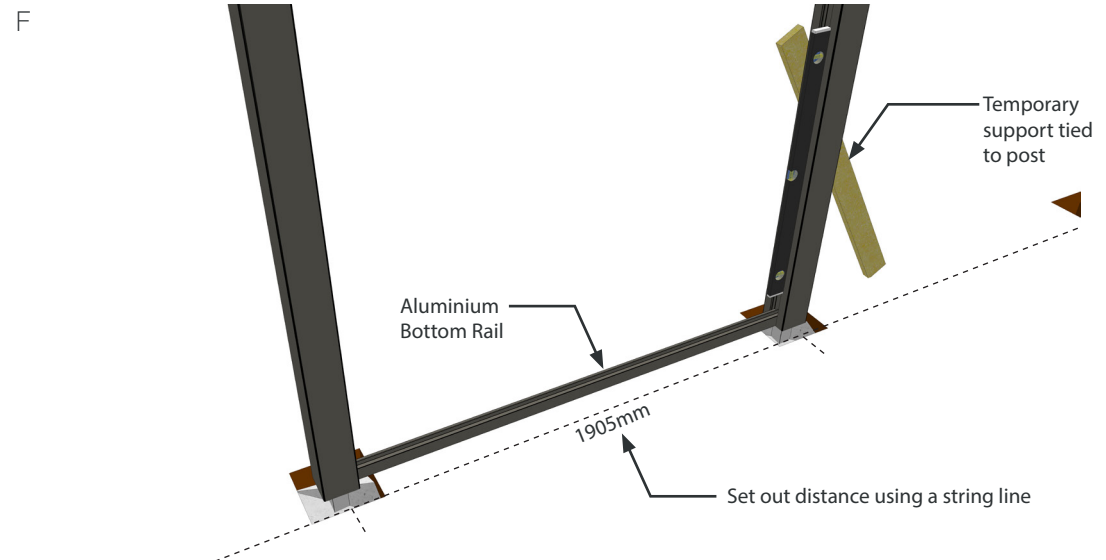

# INSTALLATION - IN GROUND OR GRASS

## STEP 4

### COMPLETE FENCE PANEL OR CONTINUE TO SET OUT POSTS

G At this point you can either:

- Complete the first fence panel by moving to step 5 on the next page, or;
- Continue to set out the remaining fence panels as per step 3.

G



H Before installing the bottom rail, you may wish to install the security clips to the bottom of the fence post to rest the fence boards on. This is particularly useful when the ground isn't sufficiently solid.

H

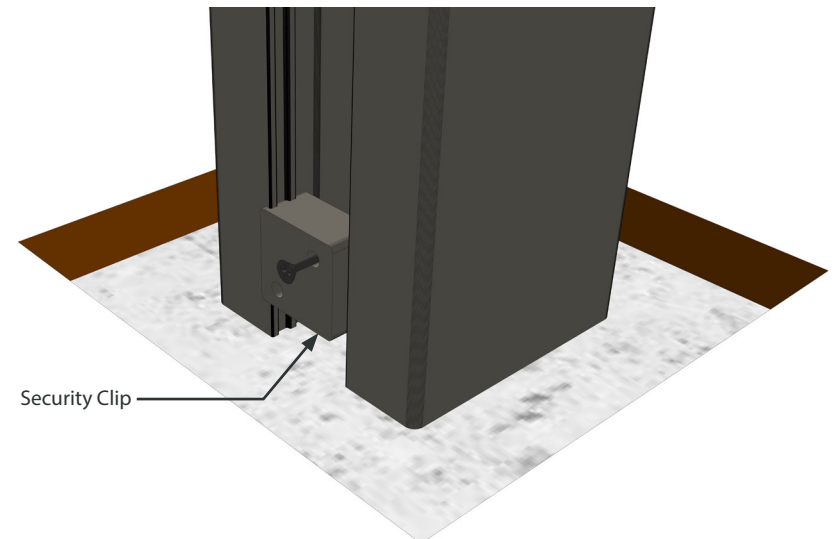

# INSTALLATION - IN GROUND OR GRASS

## STEP 5

### INSERT THE ALUMINIUM BOTTOM RAIL

- I Place the aluminium bottom rail into the H groove of the fence post and align both ends. Slide the rail down between the fence posts.

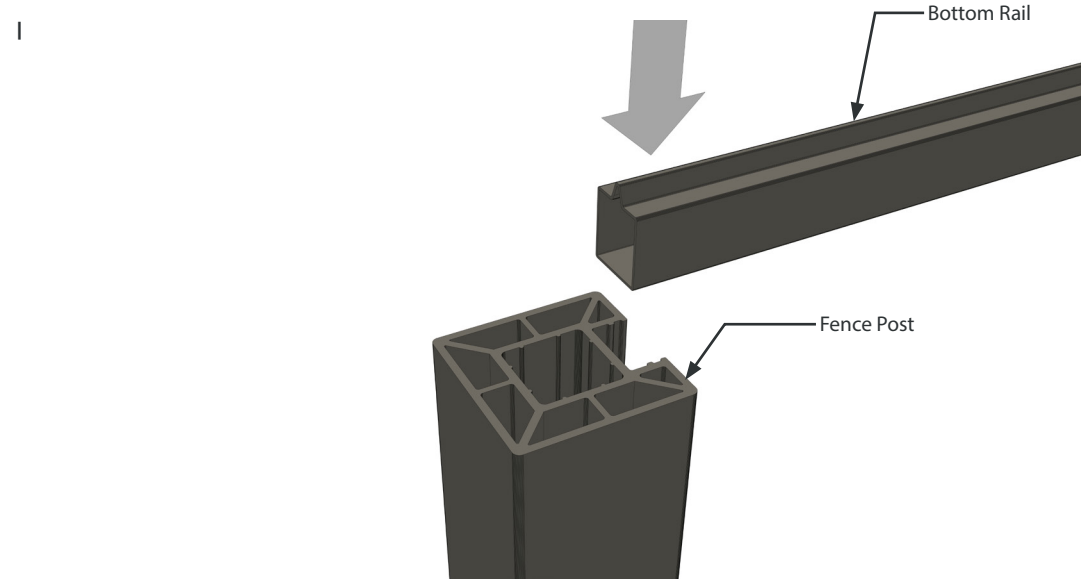

- J Level the aluminium bottom rail – the rail can be sunken into the ground if needed.

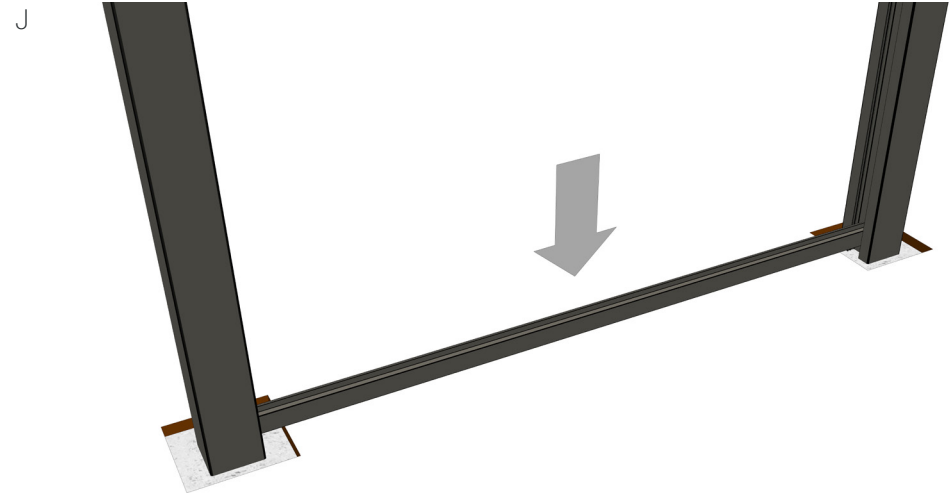



# INSTALLATION - IN GROUND OR GRASS

## STEP 6

### INSERT THE FENCE BOARDS

- K Slot the fence boards between the posts leaving a gap of 2.5mm between the end of the fence board and the post – please see table on page 6 to calculate this expansion gap.

Note – If required the fence posts can be cut to length using standard woodworking tools

K

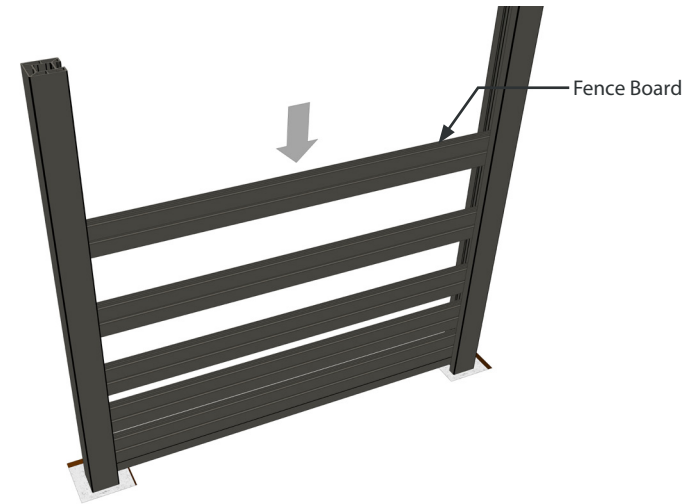

- L Stack the remaining fence boards.

L

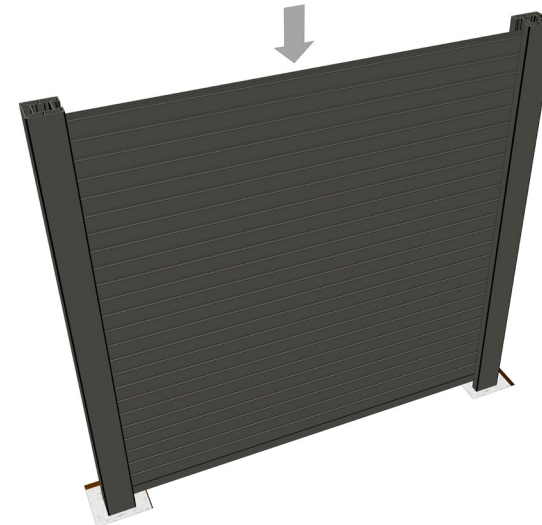

# INSTALLATION - IN GROUND OR GRASS

## STEP 7

### SLOT THE FENCE BOARDS IN BETWEEN THE POSTS

M Finish by inserting the Top Fence Panel.

M

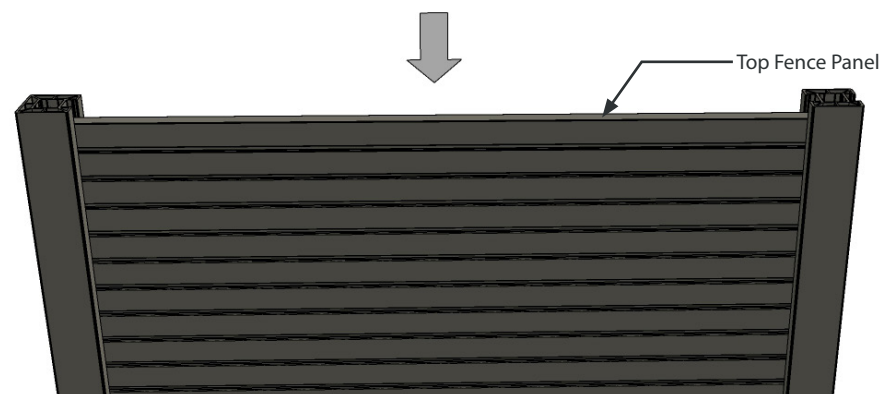

N Optional - It is possible to secure the boards in place using a security clip supplied by Ecoscape. This is simply screwed into the fence post and prevents theft of the fence boards.

Ensure that the clip is installed at least 5mm above the fence board, and 2mm from the top of the fence post to allow installation of the post cap, see next page.

Also ensure the hole is pre-drilled and the screw countersunk to achieve a flush finish. This can be done from either side as show adjacent.

N

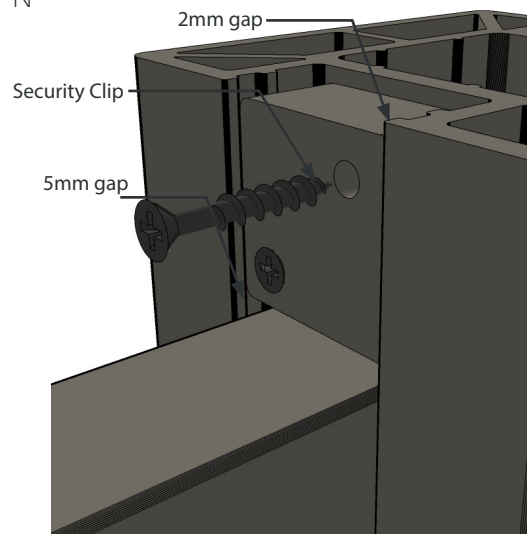

Screw from internal edge to hide fixing

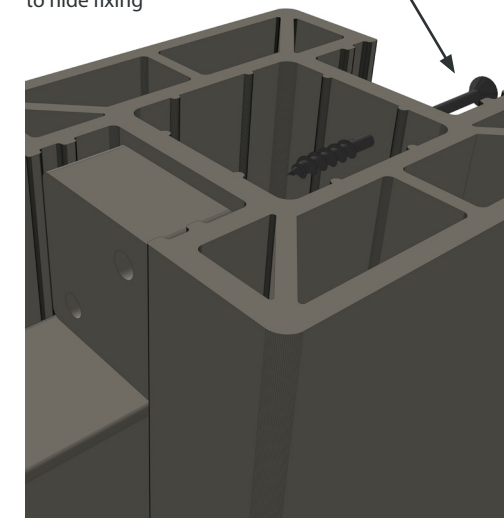

# INSTALLATION - IN GROUND OR GRASS

## STEP 8

### FINISH THE FENCE PANELS

O Insert the remaining boards and security clips as required.

O

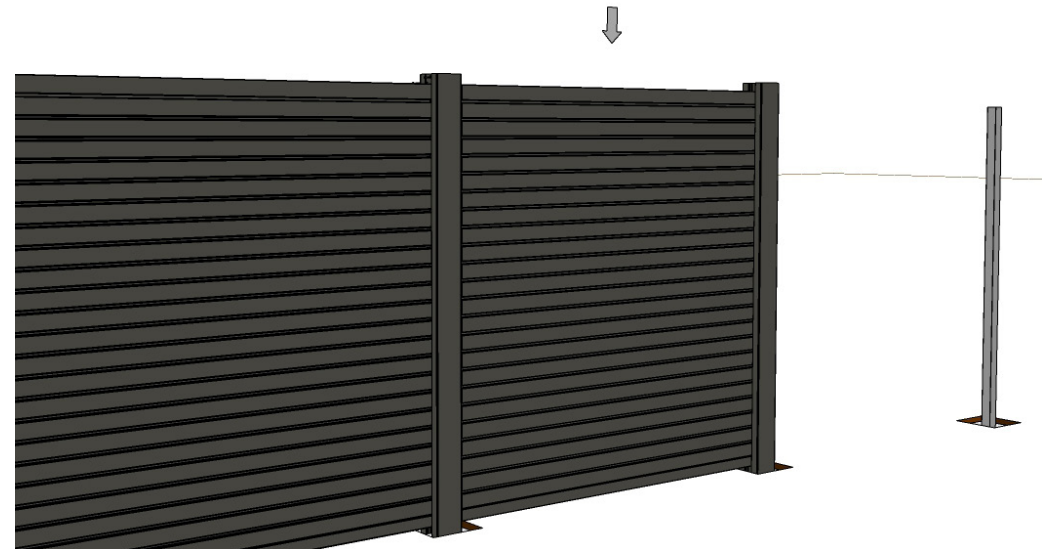

P Insert the Post Cap.

P

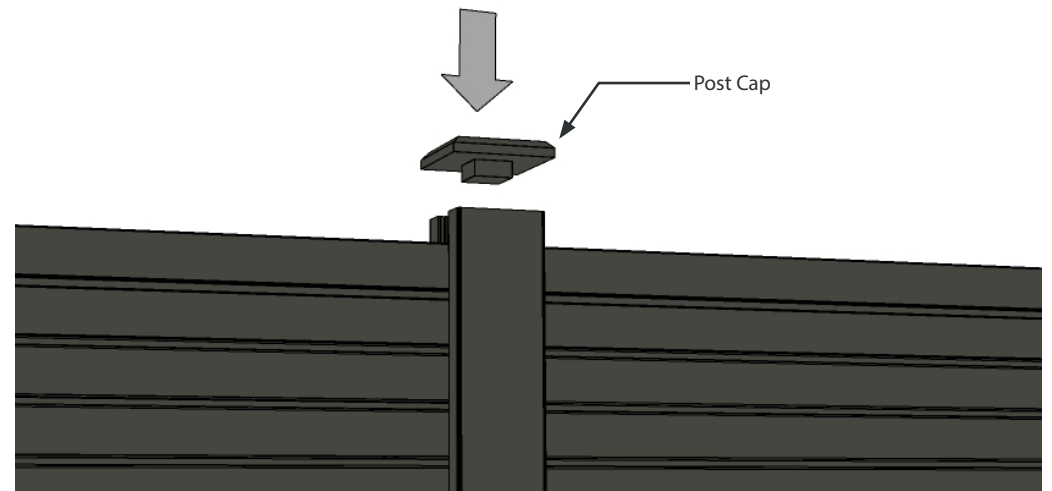

# INSTALLATION - IN GROUND OR GRASS

## STEP 9

### SECURE THE POSTS

- Q OPTIONAL - The fence posts can be secured by screwing the base and top into the steel insert. If done, the holes should be pre-drilled and the screws (self tapping) should be countersunk in place to prevent cracking.

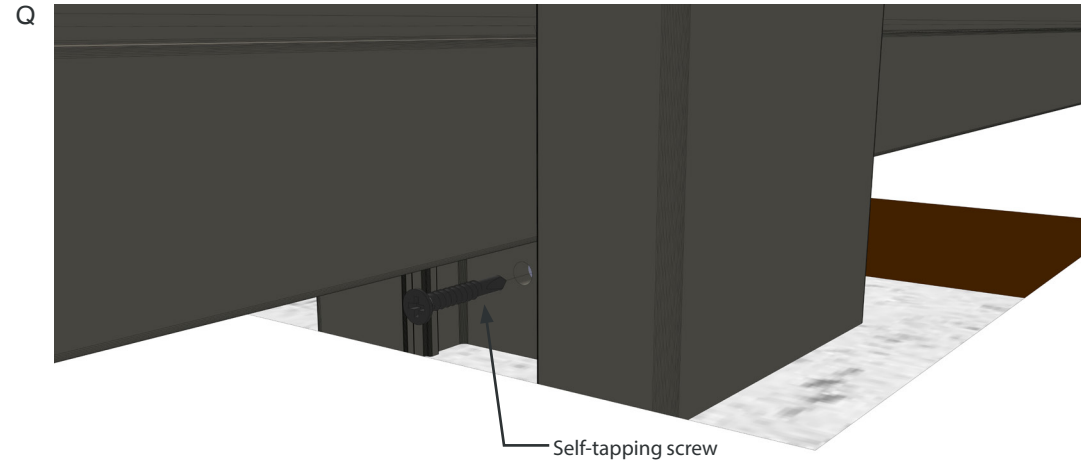

Job Done!

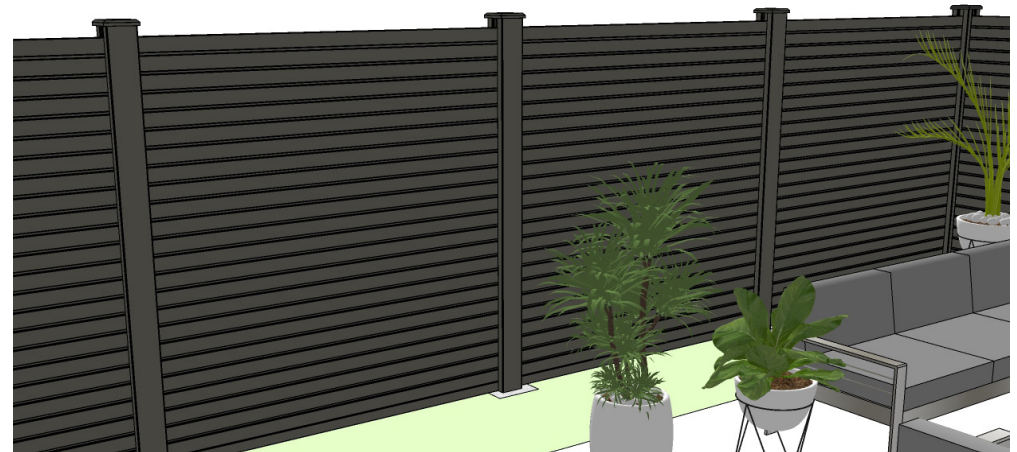

# INSTALLATION - TO CONCRETE FOOTING OR BLOCK WALL

## STEP 1

### FIX THE FENCE BASE PLATE TO THE WALL / FOOTING

- A Before starting – ensure the wall or footing is in adequate condition. Minimum depth of masonry/concrete to be 150mm thick. Ecoscape cannot take responsibility for inadequate structural foundations.

Place metal post supports in position, ensuring they are plumb/level and square to the run of the fencing. First drill 3–5mm pilot holes, Then, if you are using the supplied M10 x 80mm anchor bolts, you will need to pre-drill the structure to accept these. This should require a masonry drill bit of 13mm or 14mm diameter – depending on the substrate being fixed into.

- B Ensure the insert is plumb and secure. Use steel shims / packers if required.

A

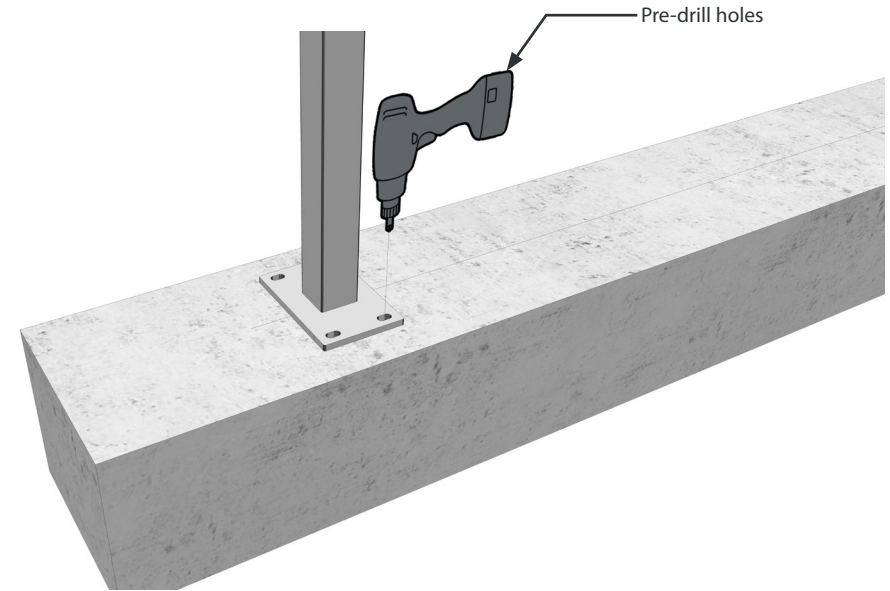

B



# INSTALLATION - TO CONCRETE FOOTING OR BLOCK WALL

## STEP 2

### ADD THE FENCE POSTS

C Ensure the bolts are sufficiently tight.

C

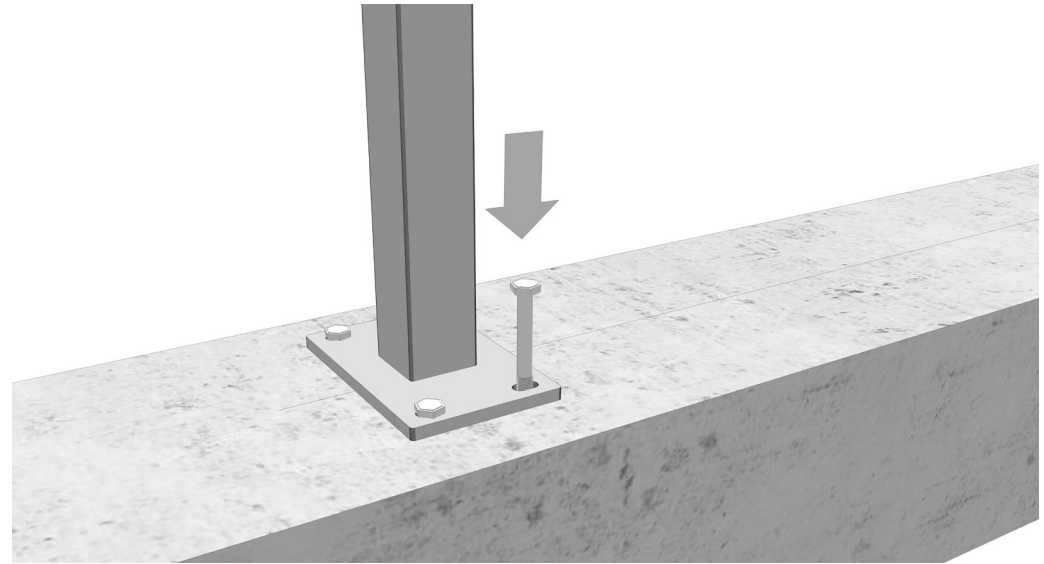

D Slide the fence post over the steel insert.

D

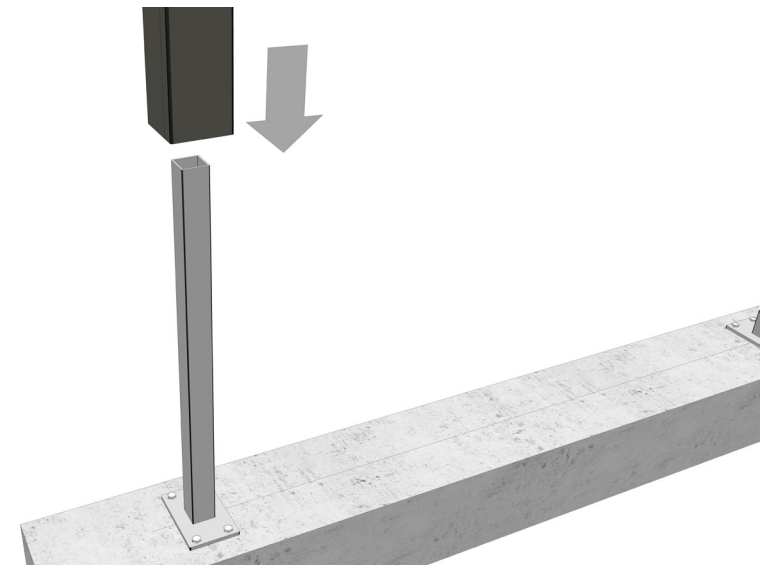

# INSTALLATION - TO CONCRETE FOOTING OR BLOCK WALL

## STEP 3

### SECURE THE FENCE POST AND INSERT BOARDS

E To secure the composite fence post to the fence base plate, pre drill through the H section of the composite post and insert a self taper. Do this twice - 150mm from the bottom and 300mm from the bottom. Self tappers are included with the base plate.

E

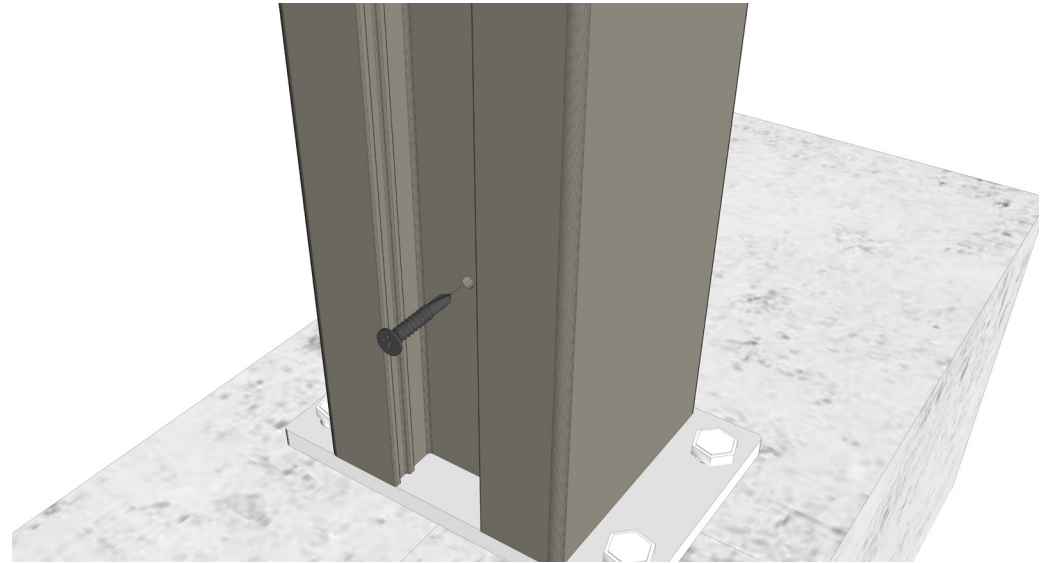

F Insert the fence boards, secure clips and post caps as per option 1.

F

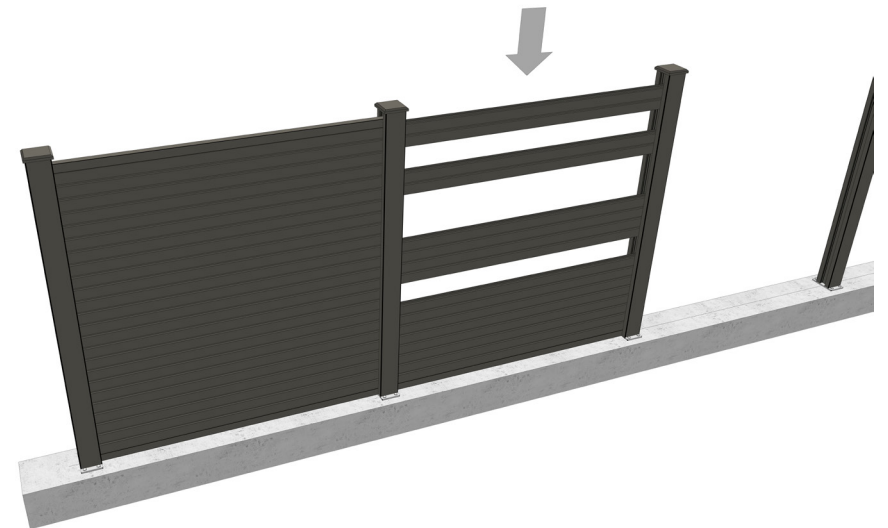

# INSTALLATION - TO CONCRETE FOOTING OR BLOCK WALL

## STEP 4

### FINISH THE REMAINING PANELS

- G Install the remaining panels and give the fixing bolts one final check to make sure their tight. Fit the plastic cover caps over the bolts.

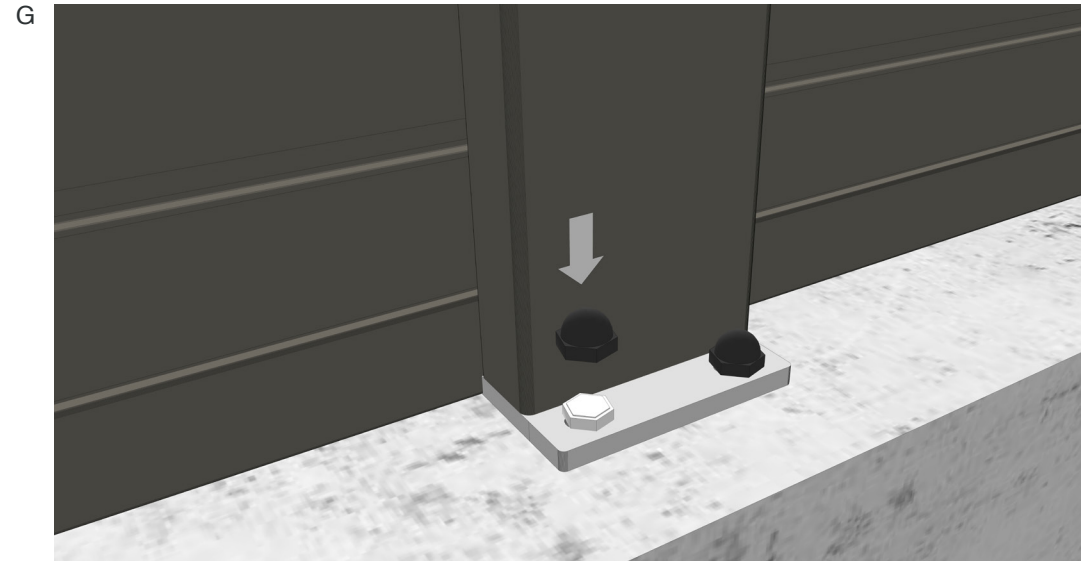

Job Done!

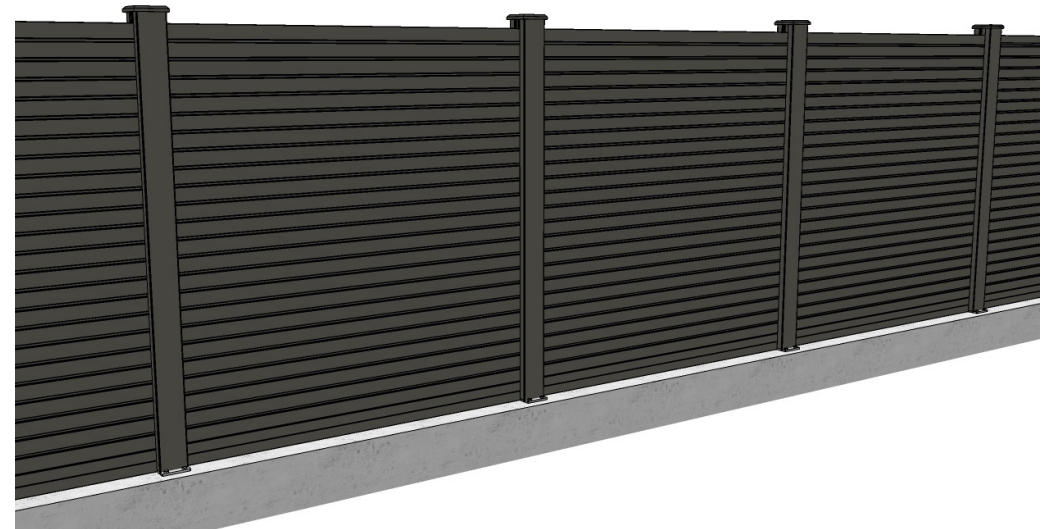



# INSTALLATION - (OPTIONAL) FENCE CAPPING BOARD POST CAP ALTERNATIVE

As an alternative to Post Caps, we now offer a Composite Capping Board, for use with our Composite Fence Posts

For Fixing the Composite Capping Board, we recommend our Colour-Coded Screws – with screwhead powdercoated to match your choice of fence colour

Fence Post Capping Board

(4000 x 145 x 23mm)



Colour Coded Screws

(63 x 5mm)



- A The Fence Capping Board can be used with our composite Fence Posts as an alternative to Fence Post Caps to give a modern look.

To fit, first follow steps above until Top Fence Panel is installed.

Once the top fence panel is in place, the Fence Capping Board should first be cut to the required length, then Posts should be cut so the top of the post is level with the top of the Top Fence Panel.

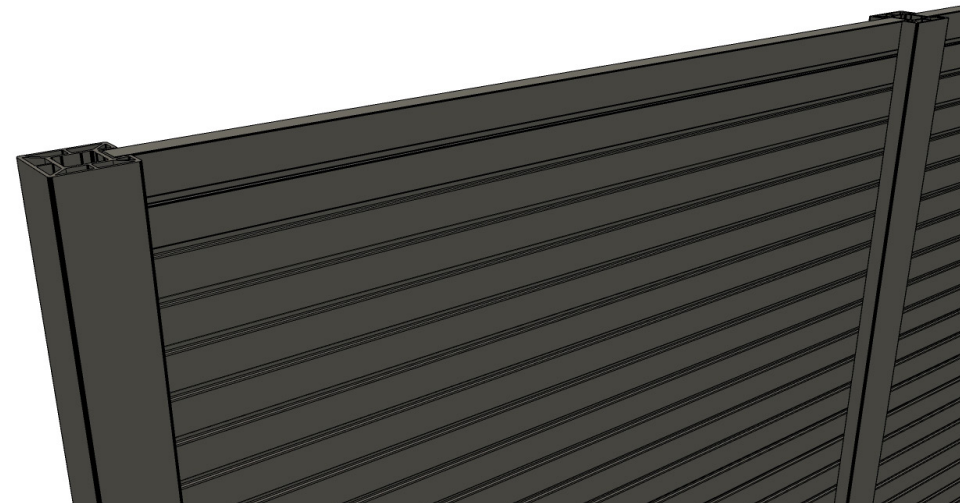

\*\* (Available in colours: Antique, Cedar, Charcoal, Graphite, Walnut).

- B The Fence Capping Board can now be placed on top of the fence, secured with Colour Coded Screws at no more than 500mm intervals (be sure to pre-drill and countersink drill holes for the screws).

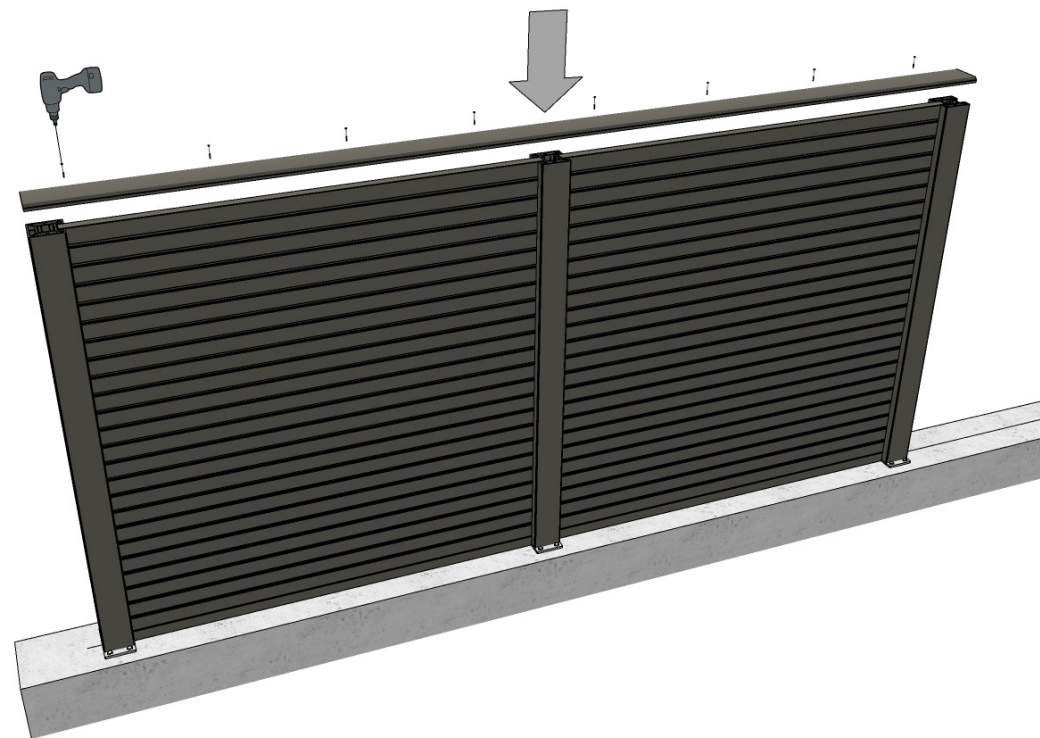

Job Done!

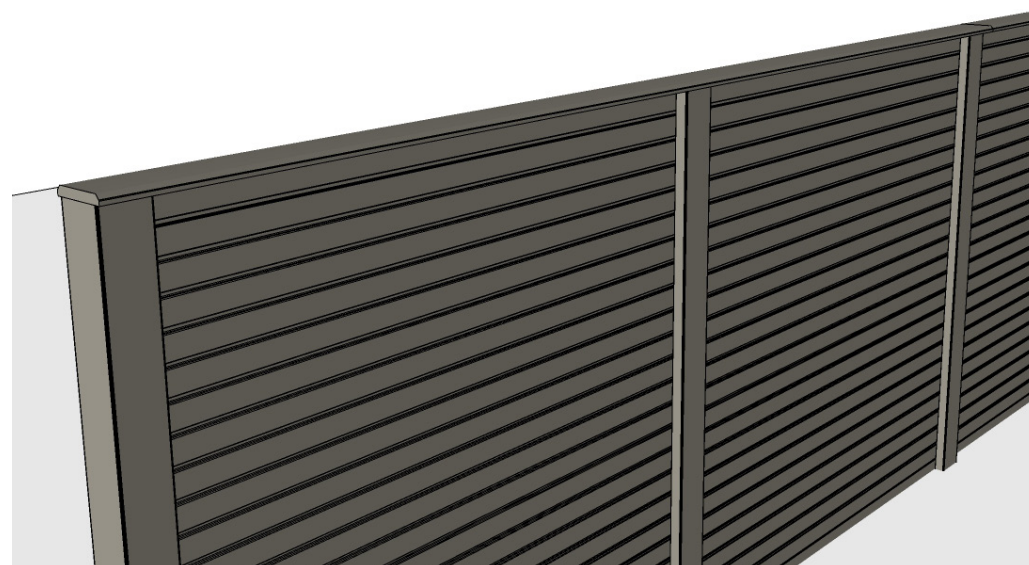

# INSTALLATION - RETROFIT

## STEP 1

### INSERT FENCE PANELS

- A With our fence boards being 45mm x 1830mm they can be slotted straight into existing concrete posts (based on a concrete post having a slot at 46.5mm – some may vary and will need packing).

Same thickness board as a timber panel, so no need for wedges or aluminium trims!

Simply take out your old timber fence panel and replace with the Ecoscape composite fence board. They just simply stack on top of one another!

- B Use packers to secure the boards where required.

A

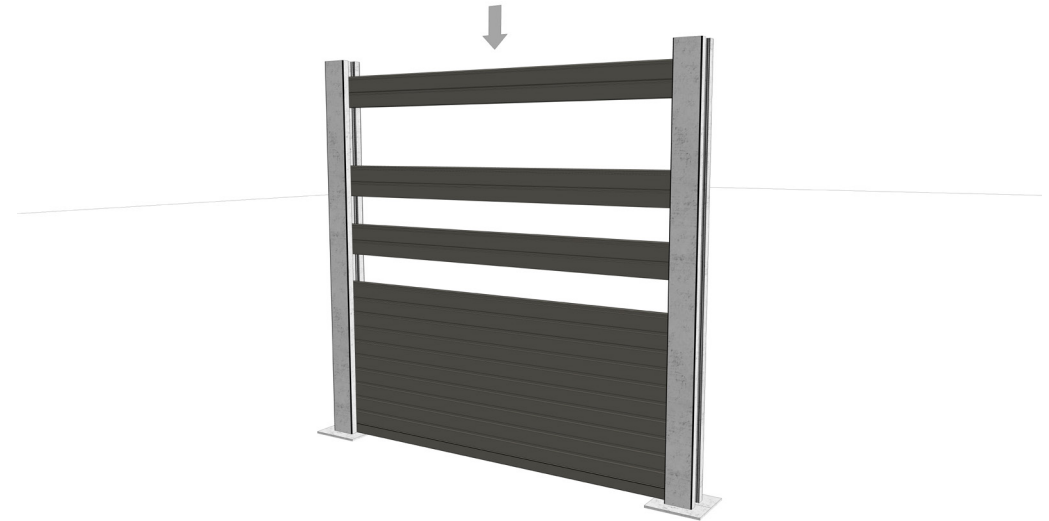

B

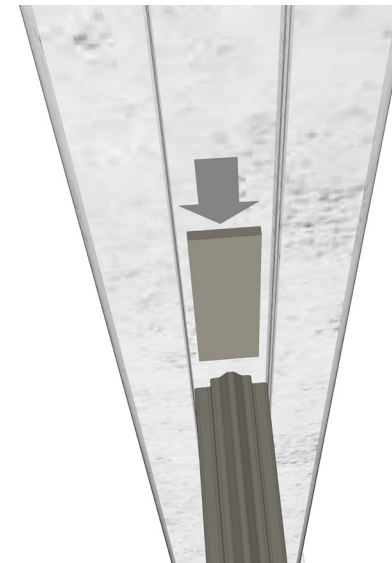

# INSTALLATION - RETROFIT

## STEP 2

### INSTALL REMAINING BOARDS

Job Done!

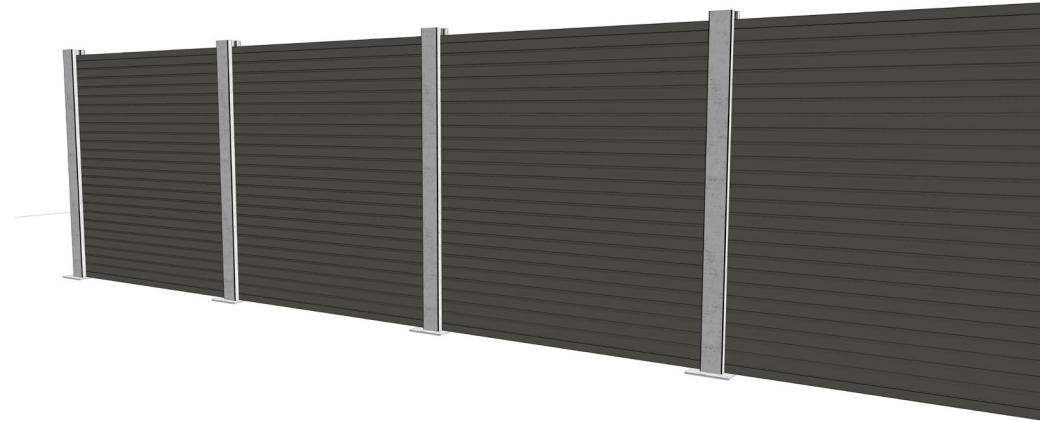

# INSTALLATION - COMPLETE

Enjoy your new fencing!

To replace any panels simply follow the installation instructions



# CLEANING AND CARE

ECOSCAPE Fencing boards will require periodic maintenance to remove the build up of dirt and debris. We recommend the fencing is cleaned once or twice a year using either:

- A high pressure cleaner (Jet wash) with a fan shaped beam at a distance of at least 20cm in a lengthwise direction, or;
- Scrubbing brush with a all-purpose cleaner and water

Burn marks, from BBQ's or similar can also be removed using a course piece of sandpaper (80gsm or similar), by rubbing the fence boards length-ways gently.

Higher Broadfield Farm,  
Off Pilsworth Road,  
Greater Manchester, OL10 2TA  
T: 0845 9011 988

E: [sales@ecoscapeuk.co.uk](mailto:sales@ecoscapeuk.co.uk)  
[www.ecoscapeuk.co.uk](http://www.ecoscapeuk.co.uk)  
2022

